



TILLOTSON LTD., CLASH INDUSTRIAL ESTATE,
TRALEE, CO. KERRY, IRELAND

PHONE: +353 66 7121911 FAX: +353 66 7124503

e-mail: sales@tillotson.ie







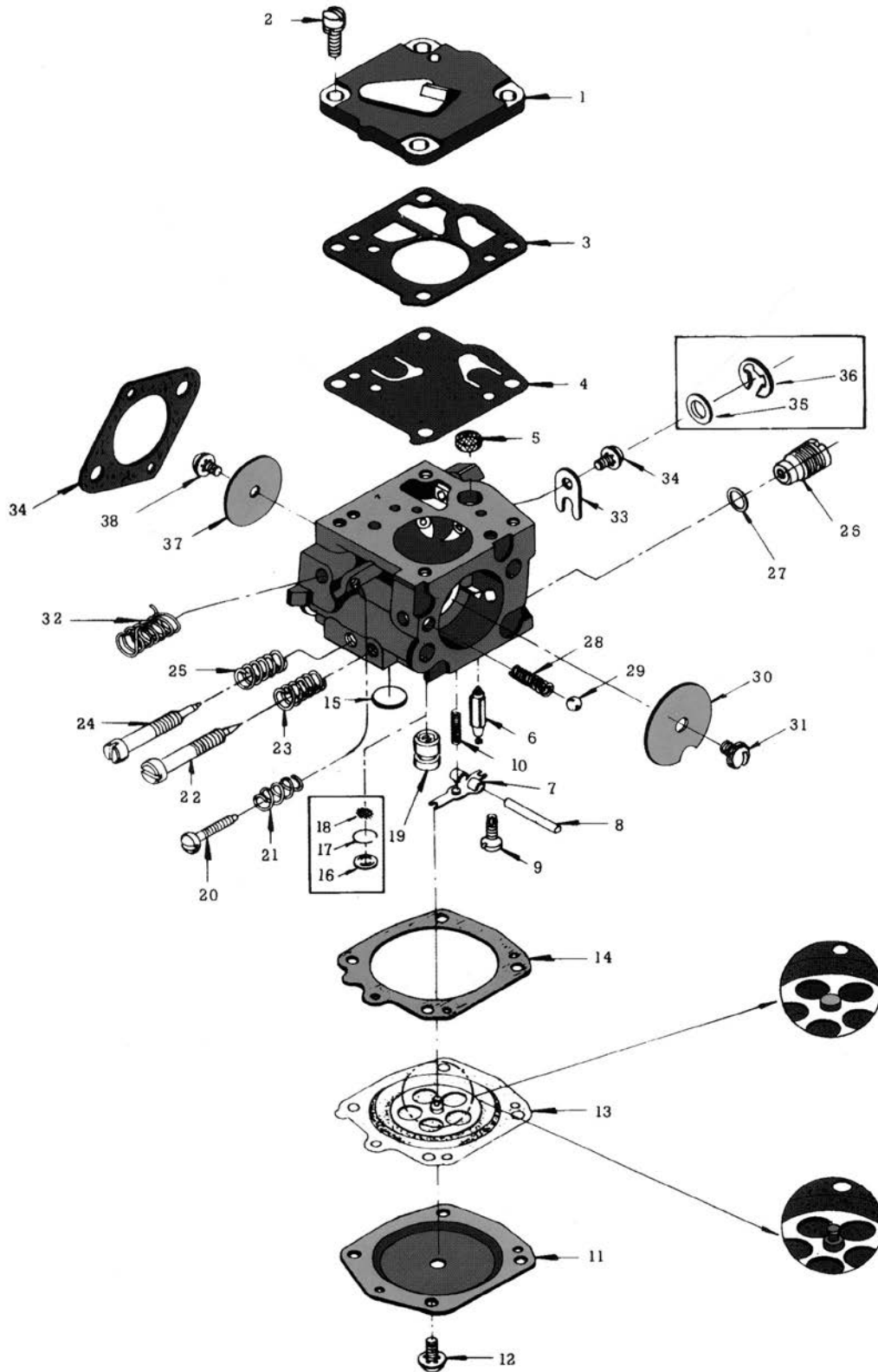







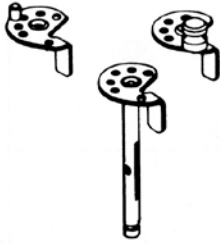



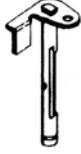



PARTS LIST

Illustration of basic parts throughout HS series carburettor.
For individual model listing see following pages.

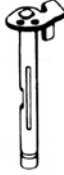



















Parts illustrated are typical in appearance and may not look exactly like the part required.





SHAFT & LEVER ASSEMBLIES

 <p>A1</p>	 <p>A2</p>	 <p>A3</p>	 <p>A4</p>	 <p>A5</p>
 <p>A6</p>	 <p>A7</p>	 <p>A8</p>	 <p>A9</p>	 <p>A10</p>
 <p>A11</p>	 <p>A12</p>	 <p>A13</p>	 <p>A14</p>	 <p>A15</p>
 <p>A16</p>	 <p>A17</p>	 <p>A18</p>	 <p>A19</p>	 <p>A20</p>
 <p>A21</p>	 <p>A22</p>	 <p>A23</p>		

MISCELLANEOUS PARTS

 B1	 B2	 B3	 B4	 B5
 B6	 B7	 B8	 B9	 B10
 B11	 B12	 B13	 B14	 B15
 B16	 B17	 B18		

LEVERS

 C1	 C2	 C3	 C4	 C5
--	--	--	--	--

Carburetor Model		HS-118B	HS-121A	HS-123A
Customer		Andreas Stihl	Husqvarna	Husqvarna
Equipment Model No.		056AV	165R	65/77/160/163/180/260
Venturi		11/16" - 17.5 MM	5/8" - 15.9 MM	263/280/380 5/8" - 15.9 MM
Ref. No.	Part Name			
1	Fuel Pump-Cover	91A-295	91A-273	91A-273
2	Fuel Pump-Cover Screw (4)	15C-30	15C-30	15C-30
+*3	Fuel Pump-Gasket	16B-227	16B-227	16B-227
+*4	Fuel Pump-Diaphragm	237-144	237-144	237-144
*5	Fuel Pump-Inlet Screen	95-177	95-177	95-177
*6	Fuel Inlet-Needle	34-216	34-216	34-216
*7	Fuel Inlet-Control Lever	155A-26	155A-26	155A-26
8	Fuel Inlet-Fulcrum Pin	32-78	32-78	32-78
9	Fuel Inlet-Fulcrum Pin Retaining Screw	15B-345	15B-345	15B-345
10	Fuel Inlet-Tension Spring	24B-299	24B-299	24B-299
11	Metering-Cover	91-786	91A-274	91A-274
12	Metering-Cover Screw (4)	15C-19	15C-19	15C-19
+*13	Metering-Diaphragm	237-653	237-601	237-601
+*14	Metering-Diaphragm Gasket	16B-226	16B-226	16B-226
*15	Metering-By Pass Chamber Welch Plug (Large)	179-59	179-59	179-59
*16	Metering-Main Nozzle Welch Plug (Small)		179-60	179-60
*17	Metering-Main Nozzle Screen		95-180	95-180
18	Metering-Main Nozzle Screen Retaining Ring		55A-212	55A-212
19	Metering-Nozzle Valve	363-518		
20	Idle Speed-Adjustment Screw		15B-330	15B-330
21	Idle Speed-Adjustment Screw Spring		24B-298	24B-298
B1	Idle Speed-Adjustment Screw Cup		318-18	318-18
22	Low Speed-Mixture Needle	43A-70	43A-70	43A-70
23	Low Speed-Mixture Needle Spring	24B-331	24B-331	24B-331
24	High Speed-Mixture Needle	43A-108	43A-71	43A-71
25	High Speed-Mixture Needle Spring	24B-449	24B-331	24B-331
26	High Speed-Governor Valve			
27	High Speed-Governor Valve Gasket			
A1	Choke-Shaft & Lever			26-1239
A11	Choke-Shaft & Lever	26-1122		
A12	Choke-Shaft & Lever			
A23	Choke-Shaft & Lever		26-1124	
28	Choke-Friction Spring	24B-281	24B-281	24B-281
29	Choke-Friction Ball	206-121	206-121	206-121
30	Choke-Shutter	27-331	27-331	27-331
31	Choke-Shutter Screw	15C-20	15C-20	15C-20
B2	Choke-Shaft Cover			91A-323
B3	Choke-Shaft Sleeve			102-204
A3	Throttle-Shaft & Lever		13-1781	13-1897
A13	Throttle-Shaft & Lever	13-2028		
A17	Throttle-Shaft & Lever			
32	Throttle-Return Spring	24B-322	24B-322	24B-437
33	Throttle-Clip	29-224		
34	Throttle-Clip Retaining Screw	15C-20		
35	Throttle-Shaft Washer		78A-226	78A-226
36	Throttle-Shaft E-Ring		29-220	29-220
37	Throttle-Shutter	14-445	14-431	14-431
38	Throttle-Shutter Screw	15C-20	15C-20	15C-20
B3	Throttle-Shaft Sleeve (2)			102-204
*39	Flange Gasket	16-B262	16B-228	16B-228
	Repair Kit		RK-23HS	RK-23HS
	Diaphragm & Gasket Set		DG-5HS/T	DG-5HS/T

*Indicates contents of Repair Kit

+Indicates contents of Diaphragm & Gasket Set

Carburetor Model		HS-158F	HS-163A	HS-172B
Customer		Alpina	Husqvarna	Partner
Equipment Model No.		070 Tendimatic/ A-70 C-70/CP-70/PROF-70	61/162SE,SG/170, 266SE, SG/PARTNER K12/R-12	P-55/P-70/P-85/P-100 P-1020/PM-1000/R-421T
Venturi		9/16"-14.3 MM	5/8"-15.9 MM	11/16"-17.5 MM
Ref. No.	Part Name			
1	Fuel Pump-Cover	91A-273	91A-273	91A-273
2	Fuel Pump-Cover Screw (4)	15C-30	15C-30	15C-30
+*3	Fuel Pump-Gasket	16B-227	16B-227	16B-227
+*4	Fuel Pump-Diaphragm	237-143	237-144	237-144
*5	Fuel Pump-Inlet Screen	95-177	95-177	95-177
*6	Fuel Inlet-Needle	34-216	34-216	34-216
*7	Fuel Inlet-Control Lever	155A-26	155A-26	155A-26
8	Fuel Inlet-Fulcrum Pin	32-78	32-78	32-78
9	Fuel Inlet-Fulcrum Pin Retaining Screw	15B-345	15B-345	15B-345
10	Fuel Inlet-Tension Spring	24B-299	24B-299	24B-299
B5	Fuel Inlet-Seat	36A-33		
11	Metering-Cover	91A-274	91B-223	91A-302
12	Metering-Cover Screw (4)	15C-19	15C-19	15C-19
+*13	Metering-Diaphragm	237-601	237-601	237-601
+*14	Metering-Diaphragm Gasket	16B-226	16B-226	16B-226
*15	Metering-By Pass Chamber Welch Plug (Large)	179-59	179-59	179-59
*16	Metering-Main Nozzle Welch Plug (Small)	179-60	179-60	
*17	Metering-Main Nozzle Screen	95-180	95-180	
18	Metering-Main Nozzle Screen Retaining Ring	55A-212	55A-212	
19	Metering-Nozzle Valve			363-518
20	Idle Speed-Adjustment Screw	15B-330		15C-21
21	Idle Speed-Adjustment Screw Spring	24B-298		
B1	Idle Speed-Adjustment Screw Cup			206-123
B6	Idle Speed-Adjustment Screw Retainer			
22	Low Speed-Mixture Needle	43A-28	43A-70	43A-9
23	Low Speed-Mixture Needle Spring	24B-331	24B-331	24B-450
24	High Speed-Mixture Needle	43A-156	43A-71	43A-10
25	High Speed-Mixture Needle Spring	24B-449	24B-449	24B-449
26	High Speed-Governor Valve			361-525
27	High Speed-Governor Valve Gasket			16B-204
A1	Choke-Shaft & Lever	26-1264		
A2	Choke-Shaft & Lever			26-1193
A4	Choke-Shaft & Lever		26-1212	
28	Choke-Friction Spring	24B-281	24B-281	24B-281
29	Choke-Friction Ball	206-121	206-121	206-121
30	Choke-Shutter	27-331	27-331	27-331
31	Choke-Shutter Screw	15C-20	15C-20	15C-20
(B2)	Choke-Shaft Cover			
(B3)	Choke-Shaft Sleeve			
A3	Throttle-Shaft & Lever	13-1944		
A5	Throttle-Shaft & Lever		13-2011	
A9	Throttle Shaft & Lever			13-1932
A18	Throttle-Shaft & Lever			
32	Throttle-Return Spring	24B-360	24B-434	24B-447
33	Throttle-Clip			
34	Throttle-Clip Retaining Screw			
35	Throttle-Shaft Washer	78A-226	78A-226	78A-226
36	Throttle-Shaft E-Ring	29-220	29-220	29-220
37	Throttle-Shutter	14-476	14-431	14-12
38	Throttle-Shutter Screw	15C-20	15C-20	15C-20
B3	Throttle-Shaft Sleeve	102-204	102-204	102-204
*39	Flange Gasket	16B228	16B228	16B-249
	Repair Kit	RK-24HS	RK-23HS	RK-23HS
	Diaphragm & Gasket Set	DG-2HS/T	DG-5HS/T	DG-5HS/T

*Indicates contents of Repair Kit

+Indicates contents of Diaphragm & Gasket Set

Carburetor Model		HS-175D	HS-175G	HS-175H
Customer		Partner	Partner	Partner
Equipment Model No.		K-65/K-650/K-1200		
		K-1200-12/K-1200-14	K650	K650
Venturi		11/16"-17.5 MM		
Ref. No.	Part Name			
1	Fuel Pump-Cover	91A-273	91A-273	91A-273
2	Fuel Pump-Cover Screw (4)	15C-30	15C-30	15C-30
+*3	Fuel Pump-Gasket	16B-227	16B-227	16B-227
+*4	Fuel Pump-Diaphragm	237-144	237-144	237-144
*5	Fuel Pump-Inlet Screen	95-177	95-177	95-177
*6	Fuel Inlet-Needle	34-216	34-219	34-219
*7	Fuel Inlet-Control Lever	155A-26	155A-26	155A-26
8	Fuel Inlet-Fulcrum Pin	32-78	32-78	32-78
9	Fuel Inlet-Fulcrum Pin Retaining Screw	15B-345	15B-345	15B-345
10	Fuel Inlet-Tension Spring	24B-299	24B-299	24B-299
B5	Fuel Inlet-Seat	36A-33	36-A39	36A-39
11	Metering-Cover	91A-302	91B-223	91B-223
12	Metering-Cover Screw (4)	15C-19	15C-54	15C-54
+*13	Metering-Diaphragm	237-601	237-687	237-687
+*14	Metering-Diaphragm Gasket	16B-226	16B-390	16B-390
*15	Metering-By Pass Chamber Welch Plug (Large)	179-59	179-59	179-59
*16	Metering-Main Nozzle Welch Plug (Small)		179-60	179-60
*17	Metering-Main Nozzle Screen			
18	Metering-Main Nozzle Screen Retaining Ring			
19	Metering-Nozzle Valve	363-598	363-598	363-598
20	Idle Speed-Adjustment Screw	15C-21	15C-21	15C-21
21	Idle Speed-Adjustment Screw Spring			
B1	Idle Speed-Adjustment Screw Cup			
B6	Idle Speed-Adjustment Screw Retainer	55A-305	55A-305	55A-305
22	Low Speed-Mixture Needle	43A-70	43A-70	49B-77
23	Low Speed-Mixture Needle Spring	24B-450	24B-450	
24	High Speed-Mixture Needle	43A-71	43A-71	49-X-21
25	High Speed-Mixture Needle Spring	24B-449	24B-449	
26	High Speed-Governor Valve	361-505	361-505	361-542
27	High Speed-Governor Valve Gasket	16B-204	16B-204	16B-204
A4	Choke-Shaft & Lever			
A12	Choke-Shaft & Lever	26-1193	26-1298	26-1307
28	Choke-Friction Spring	24B-281	24B-281	24B-281
29	Choke-Friction Ball	206-121	206-121	206-121
30	Choke-Shutter	27-331	27-369	27-369
31	Choke-Shutter Screw	15C-20	15C-20	15C-20
A3	Throttle-Shaft & Lever			
A7	Throttle-Shaft & Lever			
A11	Throttle-Shaft & Lever	13-1932	13-1932	13-1932
A13	Throttle-Shaft & Lever			
32	Throttle-Return Spring	24B-447	24B-447	24B-447
33	Throttle-Clip			
34	Throttle-Clip Retaining Screw			
35	Throttle-Shaft Washer	78A-280	78A-280	78A-280
36	Throttle-Shaft E-Ring	29-220	29-220	29-220
37	Throttle-Shutter	14A-12	14A-12	14A-12
38	Throttle-Shutter Screw	15C-20	15C-20	15C-20
B3	Throttle-Shaft Sleeve	102-204	102-204	102-204
B7	Throttle-Shaft Quod Rings (2)	44-277	44-277	44-277
B7	Throttle-Shaft Quod Ring Wahser	78A-344	78A-344	78A-344
*39	Flange Gasket	16B-249		
	Repair Kit	RK-23HS	RK-32HS	RK-32HS
	Diaphragm & Gasket Set	DG-5HS/T	DG-10HS	DG-10HS

*Indicates contents of Repair Kit

+Indicates contents of Diaphragm & Gasket Set

Carburetor Model		HS-175K		
Customer				
Equipment Model No.				
Venturi				
Ref. No.	Part Name			
1	Fuel Pump-Cover	91A-273		
2	Fuel Pump-Cover Screw (4)	15C-30		
+*3	Fuel Pump-Gasket	16B-227		
+*4	Fuel Pump-Diaphragm	237-144		
*5	Fuel Pump-Inlet Screen	95-177		
*6	Fuel Inlet-Needle	34-219		
*7	Fuel Inlet-Control Lever	155A-26		
8	Fuel Inlet-Fulcrum Pin	32-78		
9	Fuel Inlet-Fulcrum Pin Retaining Screw	15B-345		
10	Fuel Inlet-Tension Spring	24B-299		
B5	Fuel Inlet-Seat	36A-39		
11	Metering-Cover	91B-260		
12	Metering-Cover Screw (4)	15C-54		
+*13	Metering-Diaphragm	237-601		
+*14	Metering-Diaphragm Gasket	16B-226		
*15	Metering-By Pass Chamber Welch Plug (Large)	179-59		
*16	Metering-Main Nozzle Welch Plug (Small)	179-60		
*17	Metering-Main Nozzle Screen			
18	Metering-Main Nozzle Screen Retaining Ring			
19	Metering-Nozzle Valve	363-598		
20	Idle Speed-Adjustment Screw	15C-21		
21	Idle Speed-Adjustment Screw Spring			
B1	Idle Speed-Adjustment Screw Cup			
B6	Idle Speed-Adjustment Screw Retainer	55A-305		
22	Low Speed-Mixture Needle	49B-77		
23	Low Speed-Mixture Needle Spring			
24	High Speed-Mixture Needle			
25	High Speed-Mixture Needle Spring			
26	High Speed-Governor Valve	361-542		
27	High Speed-Governor Valve Gasket	16B-204		
A4	Choke-Shaft & Lever			
A12	Choke-Shaft & Lever	26-1307		
28	Choke-Friction Spring	24B-281		
29	Choke-Friction Ball	206-121		
30	Choke-Shutter	27-369		
31	Choke-Shutter Screw	15C-20		
A3	Throttle-Shaft & Lever			
A7	Throttle-Shaft & Lever			
A11	Throttle-Shaft & Lever	13-1932		
A13	Throttle-Shaft & Lever			
32	Throttle-Return Spring	24B-447		
33	Throttle-Clip			
34	Throttle-Clip Retaining Screw			
35	Throttle-Shaft Washer	78A-280		
36	Throttle-Shaft E-Ring	29-220		
37	Throttle-Shutter	14A-12		
38	Throttle-Shutter Screw	15C-20		
B3	Throttle-Shaft Sleeve	102-204		
B7	Throttle-Shaft Quod Rings (2)	44-277		
		78A-344		
*39	Flange Gasket			
	Repair Kit	RK-32HS		
	Diaphragm & Gasket Set	DG-10HS		

*Indicates contents of Repair Kit

+Indicates contents of Diaphragm & Gasket Set

Carburetor Model		HS-179B	HS-181C	
Customer		Homelite	Andreas Stihl	
Equipment Model No.		SXL-Auto/XL-12	0-41 FB	
		XL-Auto		
Venturi		9/16"-14.3 MM	9/16"-14.3 MM	
Ref. No.	Part Name			
1	Fuel Pump-Cover	91A-273	91-761	
2	Fuel Pump-Cover Screw (4)	15C-30	15C-30	
+*3	Fuel Pump-Gasket	16B-227	16B-227	
+*4	Fuel Pump-Diaphragm	237-144	237-144	
*5	Fuel Pump-Inlet Screen	95-177	95-177	
*6	Fuel Inlet-Needle	34-216	34-216	
*7	Fuel Inlet-Control Lever	155A-26	155A-26	
8	Fuel Inlet-Fulcrum Pin	32-78	32-78	
9	Fuel Inlet-Fulcrum Pin Retaining Screw	15B-345	15B-345	
10	Fuel Inlet-Tension Spring	24B-323	24B-299	
B5	Fuel Inlet-Seat			
11	Metering-Cover	91A-274	91A-295	
12	Metering-Cover Screw (4)	15C-19	15C-19	
+*13	Metering-Diaphragm	237-601	237-653	
+*14	Metering-Diaphragm Gasket	16B-226	16B-226	
*15	Metering-By Pass Chamber Welch Plug (Large)	179-59	179-59	
*16	Metering-Main Nozzle Welch Plug (Small)	179-60	179-60	
*17	Metering-Main Nozzle Screen	95-180	95-180	
18	Metering-Main Nozzle Screen Retaining Ring	55A-212	55A-212	
19	Metering-Nozzle Valve			
20	Idle Speed-Adjustment Screw			
21	Idle Speed-Adjustment Screw Spring			
B1	Idle Speed-Adjustment Screw Cup			
B6	Idle Speed-Adjustment Screw Retainer			
22	Low Speed-Mixture Needle	43-417	43A-70	
23	Low Speed-Mixture Needle Spring	24B-449	24B-331	
24	High Speed-Mixture Needle	43-418	43A-71	
25	High Speed-Mixture Needle Spring	24B-449	24B-449	
26	High Speed-Governor Valve			
27	High Speed-Governor Valve Gasket			
A4	Choke-Shaft & Lever			
A12	Choke-Shaft & Lever			
28	Choke-Friction Spring	26-1149	26-1041	
29	Choke-Friction Ball	24B-281	24B-281	
30	Choke-Shutter	206-121	206-121	
31	Choke-Shutter Screw	27-310	27-331	
			15C-20	
A3	Throttle-Shaft & Lever			
A7	Throttle-Shaft & Lever	13-1876		
A11	Throttle-Shaft & Lever			
A13	Throttle-Shaft & Lever		13-1950	
32	Throttle-Return Spring	24B-326	24B-322	
33	Throttle-Clip			
34	Throttle-Clip Retaining Screw			
35	Throttle-Shaft Washer	78A-226		
36	Throttle-Shaft E-Ring	29-220	29-220	
37	Throttle-Shutter	14-471	14-471	
38	Throttle-Shutter Screw	15C-20	15C-20	
B3	Throttle-Shaft Sleeve			
B7	Throttle-Shaft Quod Rings (2)			
B7	Throttle-Shaft Quod Ring Washer			
*39	Flange Gasket	16B-228	16B-228	
	Repair Kit	RK-23HS	RK-21HS	
	Diaphragm & Gasket Set	DG-5HS/T	DG-3HS/T	

*Indicates contents of Repair Kit

+Indicates contents of Diaphragm & Gasket Set

Carburetor Model		HS-182C	HS-187A	HS-195A
Customer		Sachs Dolmar	Sachs Dolmar	Homelite
Equipment Model No.		309 Power Cutter	123	XL-12
Venturi		11/16"-17.5 MM	11/16"-17.5 MM	9/16"-14.3 MM
Ref. No.	Part Name			
1	Fuel Pump-Cover	91A-273	91A-273	91A-273
2	Fuel Pump-Cover Screw (4)	15C-30	15C-30	15C-30
+*3	Fuel Pump-Gasket	16B-227	16B-227	16B-227
+*4	Fuel Pump-Diaphragm	237-144	237-144	237-144
*5	Fuel Pump-Inlet Screen	95-177	95-177	95-177
*6	Fuel Inlet-Needle	34-216	34-216	34-216
*7	Fuel Inlet-Control Lever	155A-26	155A-26	155A-26
8	Fuel Inlet-Fulcrum Pin	32-78	32-78	32-78
9	Fuel Inlet-Fulcrum Pin Retaining Screw	15B-345	15B-345	15B-345
10	Fuel Inlet-Tension Spring	24B-323	24B-323	24B-323
B5	Fuel Inlet-Seat			
11	Metering-Cover	91A-352	91A-352	91A-274
12	Metering-Cover Screw (4)	15C-19	15C-19	15C-19
+*13	Metering-Diaphragm	237-601	237-601	237-601
+*14	Metering-Diaphragm Gasket	16B-226	16B-226	16B-226
*15	Metering-By Pass Chamber Welch Plug (Large)	179-59	179-59	179-59
*16	Metering-Main Nozzle Welch Plug (Small)		179-60	
*17	Metering-Main Nozzle Screen		95-180	
18	Metering-Main Nozzle Screen Retaining Ring		55A-212	
19	Metering-Nozzle Valve	363-581		363-544
20	Idle Speed-Adjustment Screw	15B-330	15B-330	
21	Idle Speed-Adjustment Screw Spring	24B-298	24B-298	
B1	Idle Speed-Adjustment Screw Cup			
22	Low Speed-Mixture Needle	43A-70	43A-70	43-417
23	Low Speed-Mixture Needle Spring	24B-331	24B-331	24B-449
24	High Speed-Mixture Needle		43A-71	
25	High Speed-Mixture Needle Spring		24B-449	
26	High Speed-Governor Valve	361-534	361-525	
27	High Speed-Governor Valve Gasket	16B-204	16B-204	
A4	Choke-Shaft & Lever	26-1288	26-1037	26-1149
A14	Choke-Shaft & Lever			
28	Choke-Friction Spring	24B-281	24B-281	24B-281
29	Choke-Friction Ball	206-121	206-121	206-121
30	Choke-Shutter	27-331	27-331	27-310
31	Choke-Shutter Screw	15C-20	15C-20	
A3	Throttle-Shaft & Lever	13-1944	13-1944	
A6	Throttle-Shaft & Lever			
A7	Throttle-Shaft & Lever			13-1876
A10	Throttle-Shaft & Lever			
A13	Throttle-Shaft & Lever			
C1	Throttle-Lever			
B3	Throttle-Shaft Sleeve	102-204	102-204	
B4	Throttle-Lever Retaining Screw			
32	Throttle-Return Spring	24B-435	24B-435	24B-326
33	Throttle-Clip			
34	Throttle-Clip Retaining Screw			
35	Throttle-Shaft Washer	78A-226	78A-226	78A-226
36	Throttle-Shaft E-Ring	29-220	29-220	29-220
37	Throttle-Shutter	14-445	14-445	14-471
38	Throttle-Shutter Screw	15C-20	15C-20	15C-20
B7	Throttle-Shaft Sleeve (2)	102-204		
*39	Flange Gasket	16B-249	16B-249	16B-228
	Repair Kit	RK-23HS	RK-23HS	RK-23HS
	Diaphragm & Gasket Set	DG-5HS/T	DG-5HS/T	DG-5HS/T

*Indicates contents of Repair Kit

+Indicates contents of Diaphragm & Gasket Set

Carburetor Model		HS-203E	HS-205A
Customer		Sachs-Dolmar	Husqvarna
Equipment Model No.		133	480 CD
Venturi		11/16"-17.5 MM	11/16"-17.5 MM
Ref. No.	Part Name		
1	Fuel Pump-Cover	91A-273	91A-273
2	Fuel Pump-Cover Screw (4)	15C-30	15C-30
+*3	Fuel Pump-Gasket	16B-227	16B-227
+*4	Fuel Pump-Diaphragm	237-144	237-144
*5	Fuel Pump-Inlet Screen	95-177	95-177
*6	Fuel Inlet-Needle	34-216	34-216
*7	Fuel Inlet-Control Lever	155A-26	155A-26
8	Fuel Inlet-Fulcrum Pin	32-78	32-78
9	Fuel Inlet-Fulcrum Pin Retaining Screw	15B-345	15B-345
10	Fuel Inlet-Tension Spring	24B-323	24B-299
11	Metering-Cover	91A-352	91A-274
12	Metering-Cover Screw (4)	15C-19	15C-19
+*13	Metering-Diaphragm	237-601	237-601
+*14	Metering-Diaphragm Gasket	16B-226	16B-226
*15	Metering-By Pass Chamber Welch Plug (Large)	179-59	179-59
*16	Metering-Main Nozzle Welch Plug (Small)	179-60	179-60
*17	Metering-Main Nozzle Screen	95-180	95-180
18	Metering-Main Nozzle Screen Retaining Ring	55A-212	55A-212
19	Metering-Nozzle Valve		
20	Idle Speed-Adjustment Screw	15C-23	15B-330
21	Idle Speed-Adjustment Screw Spring		24B-298
B1	Idle Speed-Adjustment Screw Cup		318-18
B6	Idle Speed-Adjustment Screw Retainer	206-123	
22	Low Speed-Mixture Needle	43A-19	43A-70
23	Low Speed-Mixture Needle Spring	24B-331	24B-331
24	High Speed-Mixture Needle	43A-20	43A-71
25	High Speed-Mixture Needle Spring	24B-449	24B-449
26	High Speed-Governor Valve	361-529	
27	High Speed-Governor Valve Gasket	16B-204	
A1	Choke-Shaft & Lever		
A4	Choke-Shaft & Lever	26-1272	26-1212
A15	Choke-Shaft & Lever		
28	Choke-Friction Spring	24B-281	24B-281
29	Choke-Friction Ball	206-121	206-121
30	Choke-Shutter	27-331	27-331
31	Choke-Shutter Screw	15C-20	15C-20
B2	Choke-Shaft Cover		
B3	Choke-Shaft Sleeve		
B8	Choke-Shaft O-Ring		
A1	Throttle-Shaft & Lever		
A3	Throttle-Shaft & Lever		13-2096
A20	Throttle-Shaft & Lever	13-1956	
32	Throttle-Return Spring	24C-29	24B-437
33	Throttle-Clip		
34	Throttle-Clip Retaining Screw		
35	Throttle-Shaft Washer	78A-226	78A-280
36	Throttle-Shaft E-Ring	29-220	29-220
37	Throttle-Shutter	14-445	14-445
38	Throttle-Shutter Screw	15C-20	15C-20
B3	Throttle-Shaft Sleeve	102-204	102-204
B7	Throttle-Shaft Quod Ring		
*39	Flange Gasket	16B-249	16B-228
	Repair Kit	RK-23HS	RK-23HS
	Diaphragm & Gasket Set	DG-5HS/T	DG-5HS/T

*Indicates contents of Repair Kit

+Indicates contents of Diaphragm & Gasket Set

Carburetor Model		HS-216C	HS-218A	HS-219C
Customer		Husqvarna	Jonsereds	Jonsereds
Equipment Model No.		181/181SE/181SG	630	820/830/920/930
Venturi		11/16"-17.5 MM	5/8"-15.9 MM	11/16"-17.5 MM
Ref. No.	Part Name			
1	Fuel Pump-Cover	91A-273	91A-273	91-974
2	Fuel Pump-Cover Screw (4)	15C-30	15C-30	15C-30
+*3	Fuel Pump-Gasket	16B-227	16B-227	16B-227
+*4	Fuel Pump-Diaphragm	237-144	237-144	237-144
*5	Fuel Pump-Inlet Screen	95-177	95-177	95-177
*6	Fuel Inlet-Needle	34-216	34-216	34-216
*7	Fuel Inlet-Control Lever	155A-26	155A-26	155A-26
8	Fuel Inlet-Fulcrum Pin	32-78	32-78	32-78
9	Fuel Inlet-Fulcrum Pin Retaining Screw	15B-345	15B-345	15B-345
10	Fuel Inlet-Tension Spring	24B-299	24B-299	24B-323
11	Metering-Cover	91A-274	91A-274	91A-274
12	Metering-Cover Screw (4)	15C-19	15C-19	15C-19
+*13	Metering-Diaphragm	237-601	237-601	237-601
+*14	Metering-Diaphragm Gasket	16B-226	16B-226	16B-226
*15	Metering-By Pass Chamber Welch Plug (Large)	179-59	179-59	179-59
*16	Metering-Main Nozzle Welch Plug (Small)	179-60	179-60	179-60
*17	Metering-Main Nozzle Screen	95-180	95-180	95-180
18	Metering-Main Nozzle Screen Retaining Ring	55A-212	55A-212	55A-212
19	Metering-Nozzle Valve			
20	Idle Speed-Adjustment Screw			15C-21
21	Idle Speed-Adjustment Screw Spring			
B1	Idle Speed-Adjustment Screw Cup			206-123
22	Low Speed-Mixture Needle	43A-70	43A-70	43A-70
23	Low Speed-Mixture Needle Spring	24B-331	24B-331	24B-331
24	High Speed-Mixture Needle	43A-71	43A-71	43A-71
25	High Speed-Mixture Needle Spring	24B-449	24B-449	24B-449
26	High Speed-Governor Valve	361-530		
27	High Speed-Governor Valve Gasket	16B-204		
B9	High Speed-Governor Valve Anti Surge Orifice	78A-335		
C2	Choke-Lever			
C3	Choke-Lever		25-469	25-469
A4	Choke-Shaft & Lever	26-1212		
A21	Choke-Shaft & Lever		26-1260	26-1260
28	Choke-Friction Spring	24B-281		
29	Choke-Friction Ball	206-121		
30	Choke-Shutter	27-331	27-331	27-331
31	Choke-Shutter Screw	15C-20	15C-20	15C-20
B10	Choke-Shaft Return Spring			
A5	Throttle-Shaft & Lever	13-2011	24C-141	24C-141
	Throttle-Shaft & Lever		13-2012	
A13	Throttle-Shaft & Lever			
A20	Throttle-Shaft & Lever			13-1995
32	Throttle-Return Spring	24B-434	24B-434	24C-29
33	Throttle-Clip			
34	Throttle-Clip Retaining Screw			
35	Throttle-Shaft Washer	78A-226	78A-226	78A-226
36	Throttle-Shaft E-Ring	29-220	29-220	29-220
37	Throttle-Shutter	14-445	14-431	14-445
38	Throttle-Shutter Screw	15C-20	15C-20	15C-20
B3	Throttle-Shaft Sleeve	102-204	102-204	102-204
C2	Throttle-Lever		12B-363	12B-363
B4	Throttle-Lever Retaining Screw		15B-348	15B-348
*39	Flange Gasket	16B-228	16B-228	16B-249
	Repair Kit	RK-23HS	RK-23HS	RK-23HS
	Diaphragm & Gasket Set	DG-5HS/T	DG-5HS/T	DG-5HS/T

*Indicates contents of Repair Kit

+Indicates contents of Diaphragm & Gasket Set

Carburetor Model		HS-228C	HS-230D	HS-232C
Customer		Husqvarna	Jonsereds	Sachs-Dolmar
Equipment Model No.		281	J-670	SD 143
Venturi		11/16"-17.5 MM	11/16"-17.5 MM	11/16"-17.5 MM
Ref. No.	Part Name			
1	Fuel Pump-Cover	91A-273	91-996	91A-273
2	Fuel Pump-Cover Screw (4)	15C-30	15C-30	15C-30
+*3	Fuel Pump-Gasket	16B-227	16B-227	16B-227
+*4	Fuel Pump-Diaphragm	237-144	237-144	237-143
*5	Fuel Pump-Inlet Screen	95-177	95-177	95-177
*6	Fuel Inlet-Needle	34-216	34-216	34-216
*7	Fuel Inlet-Control Lever	155A-26	155A-26	155A-26
8	Fuel Inlet-Fulcrum Pin	32-78	32-78	32-78
9	Fuel Inlet-Fulcrum Pin Retaining Screw	15B-345	15B-345	15B-345
10	Fuel Inlet-Tension Spring	24B-299	24B-323	24B-323
B5	Fuel Inlet-Seat			
11	Metering-Cover	91B-223	91A-274	91A-352
12	Metering-Cover Screw (4)	15C-19	15C-19	15C-19
+*13	Metering-Diaphragm	237-601	237-601	237-601
+*14	Metering-Diaphragm Gasket	16B-226	16B-226	16B-226
*15	Metering-By Pass Chamber Welch Plug (Large)	179-59	179-59	179-59
*16	Metering-Main Nozzle Welch Plug (Small)		179-60	179-60
*17	Metering-Main Nozzle Screen		95-180	95-180
18	Metering-Main Nozzle Screen Retaining Ring		55A-212	55A-212
19	Metering-Nozzle Valve	363-629		
20	Idle Speed-Adjustment Screw		15C-21	15C-23
21	Idle Speed-Adjustment Screw Spring			
B1	Idle Speed-Adjustment Screw Cup			
B6	Idle Speed-Adjustment Screw Retainer		206-123	206-123
22	Low Speed-Mixture Needle	43A-70	43A-70	43A-19
23	Low Speed-Mixture Needle Spring		24B-449	24B-331
24	High Speed-Mixture Needle	43A-152	43A-152	43A-20
25	High Speed-Mixture Needle Spring	24B-331	24B-331	24B-449
26	High Speed-Governor Valve			361-530
27	High Speed-Governor Valve Gasket			16B-204
B9	High Speed-Governor Valve Anti Surge Orifice			
A4	Choke-Shaft & Lever	26-1212		26-1272
A21	Choke-Shaft & Lever		26-1260	
28	Choke-Friction Spring	24B-281		24B-281
29	Choke-Friction Ball	206-121		206-121
30	Choke-Shutter	27-331	27-331	27-331
31	Choke-Shutter Screw	15C-20	15C-20	15C-20
B10	Choke-Shaft Return Spring		24C-141	
C3	Choke-Lever		25-469	
A9	Throttle-Shaft & Lever		13-2040	
A20	Throttle-Shaft & Lever			13-1956
A22	Throttle-Shaft & Lever	13-2038		
32	Throttle-Return Spring	24B-434	24B-447	24C-29
35	Throttle-Shaft Washer	78A-226	78A-226	78A-226
36	Throttle-Shaft E-Ring	29-220	29-220	29-220
37	Throttle-Shutter	14-445	14-445	14-445
38	Throttle-Shutter Screw	15C-20	15C-20	15C-20
B3	Throttle-Shaft Sleeve	102-204	102-204	102-204
C2	Throttle-Lever		12B-363	
B4	Throttle-Lever Retaining Screw		15B-348	
*39	Flange Gasket	16B-228		
	Repair Kit	RK-23HS	RK-23HS	RK-24HS
	Diaphragm & Gasket Set	DG-5HS	DG-5HS	DG-5HS

*Indicates contents of Repair Kit

+Indicates contents of Diaphragm & Gasket Set

Carburetor Model		HS-236E	HS-237A	HS-239D
Customer		Sachs-Dolmar	Jonsereds	Sachs-Dolmar
Equipment Model No.		120 Super/121-S	625	392
		166 S		
Venturi		11/16"-17.5 MM	11/16"-17.5 MM	11/16"-17.5 MM
Ref. No.	Part Name			
1	Fuel Pump-Cover	91-1005	91-1008	91A-273
2	Fuel Pump-Cover Screw (4)	15C-30	15C-30	15C-30
+*3	Fuel Pump-Gasket	16B-227	16B-227	16B-227
+*4	Fuel Pump-Diaphragm	237-144	237-144	237-144
*5	Fuel Pump-Inlet Screen	95-177	95-177	95-177
*6	Fuel Inlet-Needle	34-216	34-216	34-216
*7	Fuel Inlet-Control Lever	155A-26	155A-26	155A-26
8	Fuel Inlet-Fulcrum Pin	32-78	32-78	32-78
9	Fuel Inlet-Fulcrum Pin Retaining Screw	15B-345	15B-345	15B-345
10	Fuel Inlet-Tension Spring	24B-345	24B-323	24B-323
B5	Fuel Inlet-Seat			
11	Metering-Cover	91B-235	91A-274	91A-352
12	Metering-Cover Screw (4)	15C-19	15C-19	15C-19
+*13	Metering-Diaphragm	237-601	237-601	237-601
+*14	Metering-Diaphragm Gasket	16B-226	16B-226	16B-226
*15	Metering-By Pass Chamber Welch Plug (Large)	179-59	179-59	179-59
*16	Metering-Main Nozzle Welch Plug (Small)	179-60	179-60	179-60
*17	Metering-Main Nozzle Screen	95-180	95-180	95-180
18	Metering-Main Nozzle Screen Retaining Ring	55A-212	55A-212	55A-212
19	Metering-Nozzle Valve			
20	Idle Speed-Adjustment Screw	15C-21	15C-21	15B-330
21	Idle Speed-Adjustment Screw Spring			24B-298
B1	Idle Speed-Adjustment Screw Cup			
B6	Idle Speed-Adjustment Screw Retainer	206-123	206-123	
22	Low Speed-Mixture Needle	43A-70	43A-70	43A-70
23	Low Speed-Mixture Needle Spring	24B-331	24B-331	24B-331
24	High Speed-Mixture Needle	43A-143	43A-120	
25	High Speed-Mixture Needle Spring	24B-449	24B-449	
26	High Speed-Governor Valve			361-506
27	High Speed-Governor Valve Gasket			16B-204
A4	Choke-Shaft & Lever			26-1288
A21	Choke-Shaft & Lever		26-1260	
B10	Choke-Shaft Return Spring		24C-141	
28	Choke-Friction Spring			24B-281
29	Choke-Friction Ball			206-121
30	Choke-Shutter		27-331	27-370
31	Choke-Shutter Screw		15C-20	15C-20
C3	Choke Lever		25-469	
A3	Throttle-Shaft & Lever			13-1944
A9	Throttle-Shaft & Lever		13-2040	
A20	Throttle-Shaft & Lever	13-1956		
32	Throttle-Return Spring	24C-29	24B-447	24B-435
33	Throttle-Clip			
34	Throttle-Clip Retaining Screw			
35	Throttle-Shaft Washer	78A-226	78A-226	78A-226
36	Throttle-Shaft E-Ring	29-220	29-220	29-220
37	Throttle-Shutter	14-431	14-445	14-445
38	Throttle-Shutter Screw	15C-20	15C-20	15C-20
B3	Throttle-Shaft Sleeve	102-204	102-204	102-204
B4	Throttle-Lever Retaining Screw		15B-348	
C2	Throttle-Lever			
*39	Flange Gasket	16B-249	16B-228	16B-249
	Repair Kit	RK-24HS	RK-23HS	RK-23HS
	Diaphragm & Gasket Set	DG-2HS/T	DG-5HS/T	DG-5HS/T
	Choke Valve	392-506		

*Indicates contents of Repair Kit

+Indicates contents of Diaphragm & Gasket Set

Carburetor Model		HS-240C	HS-241A	HS-250A
Customer		Wacker	Fichtel & Sachs	Jonsereds
Equipment Model No.		BS-45/BS-60Y	Earth Compactor	J670
Venturi		11/16"-17.5 MM	9/16"-14.3 MM	11/16"-17.5 MM
Ref. No.	Part Name			
1	Fuel Pump-Cover	91A-273	91-985	91-996
2	Fuel Pump-Cover Screw (4)	15C-30	15C-30	15C-30
+*3	Fuel Pump-Gasket	16B-227	16B-227	16B-227
+*4	Fuel Pump-Diaphragm	237-144	237-144	237-144
*5	Fuel Pump-Inlet Screen	95-188	95-177	95-177
*6	Fuel Inlet-Needle	34-216	34-216	34-216
*7	Fuel Inlet-Control Lever	155A-26	155A-26	155A-26
8	Fuel Inlet-Fulcrum Pin	32-78	32-78	32-78
9	Fuel Inlet-Fulcrum Pin Retaining Screw	15B-345	15B-345	15B-345
10	Fuel Inlet-Tension Spring	24B-299	24B-299	24B-323
B5	Fuel Inlet-Seat			
11	Metering-Cover	91A-282	91A-282	91A-274
12	Metering-Cover Screw (4)	15C-53	15C-53	15C-19
+*13	Metering-Diaphragm	237-686	237-601	237-601
+*14	Metering-Diaphragm Gasket	16B-226	16B-226	16B-226
*15	Metering-By Pass Chamber Welch Plug (Large)	179-59	179-59	179-59
*16	Metering-Main Nozzle Welch Plug (Small)	179-60	179-60	179-60
*17	Metering-Main Nozzle Screen	95-180	95-180	95-180
18	Metering-Main Nozzle Screen Retaining Ring	55A-212	55A-212	55A-212
20	Idle Speed-Adjustment Screw			15C-21
B6	Idle Speed-Adjustment Screw Retainer			206-123
22	Low Speed-Mixture Needle	43-420	43-420	43A-70
23	Low Speed-Mixture Needle Spring	24B-331	24B-331	24B-331
24	High Speed-Mixture Needle	49B-1		43A-71
25	High Speed-Mixture Needle Spring			24B-449
26	High Speed-Governor Valve	15C-14	15C-14	
27	High Speed-Governor Valve Gasket	16B-184	16B-184	
B12	High Speed-Jet		49A-441	
A2	Choke-Shaft & Lever	26-1279		
A16	Choke-Shaft & Lever		26-1280	
A21	Choke-Shaft & Lever			26-1260
28	Choke-Friction Spring	24B-281	24B-281	
29	Choke-Friction Ball	206-121	206-121	
30	Choke-Shutter	27-342	27-342	27-331
31	Choke-Shutter Screw	15C-20	15C-20	15C-20
B2	Choke-Shaft Cover	91B-208	91B-208	
B3	Choke-Shaft Sleeve	102-204	102-204	
B8	Choke-Shaft O-Ring	44-296	44-296	
B10	Choke-Shaft Return Spring			24C-141
B17	Choke-Shaft E-Ring			29-220
C3	Choke-Lever			25-469
A9	Throttle-Shaft & Lever			13-2040
A16	Throttle-Shaft & Lever	13-2093	13-2037	
32	Throttle-Return Spring	24B-435	24B-360	24B-447
33	Throttle-Clip	29-224	29-224	
34	Throttle-Clip Retaining Screw	15C-20	15C-20	
35	Throttle-Shaft Washer			78A-226
36	Throttle-Shaft E-Ring			29-220
37	Throttle-Shutter	14A-26	14A-10	14-445
38	Throttle-Shutter Screw	15C-20	15C-20	15C-20
B3	Throttle-Shaft Sleeve	102-204		102-204
C4	Throttle-Lever			12B-363
B4	Throttle-Lever Retaining Screw			15B-348
*39	Flange Gasket	16B-228	16B-249	16B-228
	Repair Kit	RK-26HS	RK-23HS	RK-26HS
	Diaphragm & Gasket Set	DG-8HS	DG-5HS/T	DG-8HS

*Indicates contents of Repair Kit

+Indicates contents of Diaphragm & Gasket Set

Carburetor Model		HS-251A	HS-252A	HS-254B
Customer		Jonsereds	Jonsereds	Husqvarna
Equipment Model No.		625	630	H66/H266/366
Venturi		11/16"-17.5 MM	11/16"-17.5 MM	11/16"-17.5 MM
Ref. No.	Part Name			
1	Fuel Pump-Cover	91-996	91A-273	91A-273
2	Fuel Pump-Cover Screw (4)	15C-30	15C-30	15C-30
+*3	Fuel Pump-Gasket	16B-227	16B-227	16B-227
+*4	Fuel Pump-Diaphragm	237-144	237-144	237-144
*5	Fuel Pump-Inlet Screen	95-177	95-177	95-177
*6	Fuel Inlet-Needle	34-216	34-216	34-216
*7	Fuel Inlet-Control Lever	155A-26	155A-26	155A-26
8	Fuel Inlet-Fulcrum Pin	32-78	32-78	32-78
9	Fuel Inlet-Fulcrum Pin Retaining Screw	15B-345	15B-345	15B-345
10	Fuel Inlet-Tension Spring	24B-323	24B-323	24B-299
11	Metering-Cover	91A-274	91A-274	91B-223
12	Metering-Cover Screw (4)	15C-19	15C-19	15C-19
+*13	Metering-Diaphragm	237-601	237-601	237-601
+*14	Metering-Diaphragm Gasket	16B-226	16B-226	16B-226
*15	Metering-By Pass Chamber Welch Plug (Large)	179-59	179-59	179-59
*16	Metering-Main Nozzle Welch Plug (Small)	179-60	179-60	
*17	Metering-Main Nozzle Screen	95-180	95-180	
18	Metering-Main Nozzle Screen Retaining Ring	55A-212	55A-212	
19	Metering-Nozzle Valve			363-619
20	Idle Speed-Adjustment Screw	15C-21		15C-21
21	Idle Speed-Adjustment Screw Spring			
B1	Idle Speed-Adjustment Screw Cup			
B6	Idle Speed-Adjustment Screw Retainer	206-123		206-123
22	Low Speed-Mixture Needle	43A-70	43A-70	43A-70
23	Low Speed-Mixture Needle Spring	24B-331	24B-331	24B-331
24	High Speed-Mixture Needle	43A-120	43A-71	43A-71
25	High Speed-Mixture Needle Spring	24B-449	24B-449	24B-449
26	High Speed-Governor Valve			
27	High Speed-Governor Valve Gasket			
A21	Choke-Shaft & Lever	26-1260	26-1260	
28	Choke-Friction Spring			26-1266
29	Choke-Friction Ball			24B-281
30	Choke-Shutter	27-331	27-331	206-121
31	Choke-Shutter Screw	15C-20	15C-20	27-331
B10	Choke-Shaft Return Spring	24C-141	24C-141	15C-20
B17	Choke-Shaft E-Ring	29-220	29-220	
C3	Choke-Lever	25-469	25-469	
A9	Throttle-Shaft & Lever	13-2040	13-2012	
32	Throttle-Return Spring	24B-447	24B-434	13-2043
33	Throttle-Clip			24B-447
34	Throttle-Clip Retaining Screw			
35	Throttle-Shaft Washer	78A-226	78A-226	78A-226
36	Throttle-Shaft E-Ring	29-220	29-220	29-220
37	Throttle-Shutter	14-445	14-445	14-445
38	Throttle-Shutter Screw	15C-20	15C-20	15C-20
B3	Throttle-Shaft Sleeve	102-204	102-204	102-204
C2	Throttle-Lever	12B-363	12B-363	
B4	Throttle-Lever Retaining Screw	15B-348	15B-348	
*39	Flange Gasket	16B-228	16B-228	16B-228
	Repair Kit	RK-23HS	RK-23HS	RK-23HS
	Diaphragm & Gasket Set	DG-5HS/T	DG-5HS/T	DG-5HS/T

*Indicates contents of Repair Kit

+Indicates contents of Diaphragm & Gasket Set

Carburetor Model		HS-255B	HS-256A
Customer		Husqvarna	Jonsereds
Equipment Model No.		H272KAP	J630
Venturi		11/16"-17.5 MM	11/16"-17.5 MM
Ref. No.	Part Name		
1	Fuel Pump-Cover	91A-273	91A-273
2	Fuel Pump-Cover Screw (4)	15C-30	15C-30
+*3	Fuel Pump-Gasket	16B-227	16B-227
+*4	Fuel Pump-Diaphragm	237-143	237-144
*5	Fuel Pump-Inlet Screen	95-177	95-177
*6	Fuel Inlet-Needle	34-216	34-216
*7	Fuel Inlet-Control Lever	155A-26	155A-26
8	Fuel Inlet-Fulcrum Pin	32-78	32-78
9	Fuel Inlet-Fulcrum Pin Retaining Screw	15B-345	15B-345
10	Fuel Inlet-Tension Spring	24B-345	24B-323
11	Metering-Cover	91A-274	91A-274
12	Metering-Cover Screw (4)	15C-19	15C-19
+*13	Metering-Diaphragm	237-601	237-601
+*14	Metering-Diaphragm Gasket	16B-226	16B-226
*15	Metering-By Pass Chamber Welch Plug (Large)	179-59	179-59
*16	Metering-Main Nozzle Welch Plug (Small)	179-60	179-60
*17	Metering-Main Nozzle Screen	95-180	95-180
18	Metering-Main Nozzle Screen Retaining Ring	55A-305	55A-212
19	Metering-Nozzle Valve	363-598	
20	Idle Speed-Adjustment Screw	15C-21	15C-21
21	Idle Speed-Adjustment Screw Spring		
B1	Idle Speed-Adjustment Screw Cup		
B6	Idle Speed-Adjustment Screw Retainer		
22	Low Speed-Mixture Needle	43A-70	43A-70
23	Low Speed-Mixture Needle Spring	24B-450	24B-331
24	High Speed-Mixture Needle	43A-71	43A-71
25	High Speed-Mixture Needle Spring	24B-449	24B-449
26	High Speed-Governor Valve	361-542	
27	High Speed-Governor Valve Gasket	16B-204	
A4	Choke-Shaft & Lever	26-1266	
A21	Choke-Shaft & Lever		26-1260
28	Choke-Friction Spring	24B-281	
29	Choke-Friction Ball	206-121	206-123
30	Choke-Shutter	27-331	
31	Choke-Shutter Screw	15C-20	15C-20
B10	Choke-Shaft Return Spring		24C-141
B17	Choke-Shaft E-Ring		29-220
C3	Choke-Lever		25-469
A5	Throttle-Shaft & Lever		13-2040
A9	Throttle-Shaft & Lever	13-2043	
32	Throttle-Return Spring	24B-447	24B-447
33	Throttle-Clip		
34	Throttle-Clip Retaining Screw		
35	Throttle-Shaft Washer	78A-280	78A-226
36	Throttle-Shaft E-Ring	29-220	29-220
37	Throttle-Shutter	14A-12	14-445
38	Throttle-Shutter Screw	15C-20	15C-20
B3	Throttle-Shaft Sleeve	102-204	102-204
C2	Throttle-Lever		12B-363
B4	Throttle-Lever Retaining Screw		15B-348
*39	Flange Gasket	16B-228	16B-228
	Repair Kit	RK-24HS	RK-23HS
	Diaphragm & Gasket Set	DG-2HS/T	DG-5HS/T

*Indicates contents of Repair Kit

+Indicates contents of Diaphragm & Gasket Set

Carburetor Model		HS-260A	HS-265A	HS-273A
Customer		Husqvarna	Jonsereds	Dolmar
Equipment Model No.		H268XPS	J2084	PC7314
Venturi		11/16"-17.5 MM	11/16"-17.5 MM	
Ref. No.	Part Name			
1	Fuel Pump-Cover	91A-273	91-761	91-1010
2	Fuel Pump-Cover Screw (4)	15C-30	15C-30	15C-30
+*3	Fuel Pump-Gasket	16B-227	16B-227	16B-227
+*4	Fuel Pump-Diaphragm	237-144	237-144	237-144
*5	Fuel Pump-Inlet Screen	95-177	95-177	95-233
*6	Fuel Inlet-Needle	34-216	34-216	34-219
*7	Fuel Inlet-Control Lever	155A-26	155A-26	155A-26
8	Fuel Inlet-Fulcrum Pin	32-78	32-78	32-78
9	Fuel Inlet-Fulcrum Pin Retaining Screw	15B-345	15B-345	15B-345
10	Fuel Inlet-Tension Spring	24B-299	24B-323	24B-345
B5	Fuel Inlet-Seat			
11	Metering-Cover	91B-233	91A-274	91B-255
12	Metering-Cover Screw (4)	15C-19	15C-19	15C-19
+*13	Metering-Diaphragm	237-601	237-601	237-601
+*14	Metering-Diaphragm Gasket	16B-226	16B-226	16B-226
*15	Metering-By Pass Chamber Welch Plug (Large)	179-59	179-59	179-59
*16	Metering-Main Nozzle Welch Plug (Small)			
*17	Metering-Main Nozzle Screen			
18	Metering-Main Nozzle Screen Retaining Ring		55A-305	
19	Metering-Nozzle Valve	363-616	363-619	363-639
20	Idle Speed-Adjustment Screw	15C-21	15C-21	15C-44
21	Idle Speed-Adjustment Screw Spring			
B1	Idle Speed-Adjustment Screw Cup			
B6	Idle Speed-Adjustment Screw Retainer	206-123		55A-305
22	Low Speed-Mixture Needle	43A-70	43A-70	43A-172
23	Low Speed-Mixture Needle Spring	24B-331	24B-331	24B-331
24	High Speed-Mixture Needle	43A-152	43A-71	43A-173
25	High Speed-Mixture Needle Spring	24B-449	24B-449	24B-331
26	High Speed-Governor Valve			
27	High Speed-Governor Valve Gasket			
A4	Choke-Shaft & Lever	26-1266	26-1274	
A21	Choke-Shaft & Lever			26-1304
28	Choke-Friction Spring	24B-281		24B-281
29	Choke-Friction Ball	206-121		206-121
30	Choke-Shutter	27-331	27-331	27-331
31	Choke-Shutter Screw	15C-20	15C-20	15C-20
B10	Choke-Shaft Return Spring		24C-141	
B17	Choke-Shaft E-Ring			
C3	Choke-Lever		25-469	
C5	Choke-Lever		25-457	
A3	Throttle-Shaft & Lever			13-2043
A5	Throttle-Shaft & Lever		13-2049	
A9	Throttle-Shaft & Lever	13-2043		24B-447
B4	Throttle-Lever Retaining Screw		15B-348	
32	Throttle-Return Spring	24B-447	24C-239	
33	Throttle-Clip			
34	Throttle-Clip Retaining Screw			
35	Throttle-Shaft Washer	78A-226	78A-280	78A-226
36	Throttle-Shaft E-Ring	29-220	29-220	29-220
37	Throttle-Shutter	14-445	14A-8	14-445
38	Throttle-Shutter Screw	15C-20	15C-20	15C-20
B3	Throttle-Shaft Sleeve	102-204		102-204
C2	Throttle-Lever		12B-363	
B4	Throttle-Lever Retaining Screw		15B-348	
*39	Flange Gasket	16B-228		
46				49B-43
	Repair Kit	RK-23HS	RK-23HS	RK-32HS
	Diaphragm & Gasket Set	DG-5HS/T	DG-5HS/T	DG-5HS/T

*Indicates contents of Repair Kit

+Indicates contents of Diaphragm & Gasket Set

Carburetor Model		HS-274E	HS-275B	HS-276D
Customer		Stihl	Stihl	Stihl
Equipment Model No.				
		4223-120-0600D	4221	4221-120-0602C
Venturi				
Ref. No.	Part Name			
1	Fuel Pump-Cover	91-786	91A-273	91A-273
2	Fuel Pump-Cover Screw (4)	15C-30	15C-30	15C-30
+*3	Fuel Pump-Gasket	16B-227	16B-227	16B-227
+*4	Fuel Pump-Diaphragm	237-143	237-143	237-143
*5	Fuel Pump-Inlet Screen	95-233	95-233	95-233
*6	Fuel Inlet-Needle	34-219	34-219	34-219
*7	Fuel Inlet-Control Lever	155A-71	155A-71	155A-71
8	Fuel Inlet-Fulcrum Pin	32-78	32-78	32-78
9	Fuel Inlet-Fulcrum Pin Retaining Screw	15B-345	15B-345	15B-345
10	Fuel Inlet-Tension Spring	24B-345	24B-345	24B-345
11	Metering-Cover	91-1006	91-1003	91-1003
12	Metering-Cover Screw (4)	15C-19	15C-53	15C-53
+*13	Metering-Diaphragm	237-653	237-653	237-653
+*14	Metering-Diaphragm Gasket	16B-226	16B-226	16B-226
*15	Metering-By Pass Chamber Welch Plug (Large)	179-59	179-59	179-59
*16	Metering-Main Nozzle Welch Plug (Small)			
*17	Metering-Main Nozzle Screen			
18	Metering-Main Nozzle Screen Retaining Ring			
19	Metering-Nozzle Valve	363-643	363-626	363-626
20	Idle Speed-Adjustment Screw	15C-44	15C-44	15C-44
21	Idle Speed-Adjustment Screw Spring			
B1	Idle Speed-Adjustment Screw Cup			
B6	Idle Speed-Adjustment Screw Retainer	55A-305	55A-305	55A-305
22	Low Speed-Mixture Needle	43A-176	43A-176	43A-176
23	Low Speed-Mixture Needle Spring	24B-331	24B-331	24B-331
24	High Speed-Mixture Needle	43A-173		43A-177
25	High Speed-Mixture Needle Spring	24B-331		24B-331
26	High Speed-Governor Valve			
27	High Speed-Governor Valve Gasket			
B8	High Speed-Mixture Screw 'O' Ring	44-350	44-350	44-350
A4	Choke-Shaft & Lever	26A-215		
A21	Choke-Shaft & Lever		26-1306	26-1306
A22	Choke-Shaft & Lever			
A23	Choke-Shaft & Lever		26A-212	26A-212
30	Choke-Shutter	27-372	27-331	27-331
31	Choke-Shutter Screw	15C-20	15C-20	15C-20
B10	Choke-Shaft Return Spring	24C-266	24C-272	24C-264
B17	Choke-Shaft E-Ring	29-220	29-220	29-220
B9	Choke-Shaft Dust Seal (2)	44-347	44-347	44-347
B3	Choke-Dust Seal Retainer (2)	102-219	102-217	102-219
B14	Choke-Plastic Lever		25-494	25-494
B15	Choke-Compression Spring	24C-266		
A3	Throttle-Shaft & Lever	13-2112	13-2111	13-2091
32	Throttle-Return Spring	24C-265	24C-29	24C-29
35	Throttle-Shaft Washer	78A-226	78A-226	78A-226
36	Throttle-Shaft E-Ring	29-220	29-220	29-220
37	Throttle-Shutter	14A-58	14A-42	14A-42
38	Throttle-Shutter Screw	15C-20	15C-20	15C-20
B5	Throttle-Wire Connector		28-176	28-176
C2	Throttle-Lever	12B-448		
B4	Throttle-Lever Retaining Screw	15B-348	15B-348	15B-348
B7	Throttle-Shaft Sleeve		102-204	102-204
B18	Throttle-Wire Connector E-Ring		29-223	29-223
C5	Throttle-Shaft Lever	12B-448		
	Jet-Remote Fixed	49B-4	49B-14	49A-499
	Jet-Part Throttle	363-625	363-625	363-625
	Repair Kit	RK-28HS	RK-28HS	RK-28HS
	Diaphragm & Gasket Set	DG-7HS	DG-7HS	DG-7HS

*Indicates contents of Repair Kit

+Indicates contents of Diaphragm & Gasket Set

Carburetor Model		HS-277A	HS-278F
Customer		Stihl	Wacker
Equipment Model No.			
		4205	BS 700
Venturi			
Ref. No.	Part Name		
1	Fuel Pump-Cover	91-761	91A-273
2	Fuel Pump-Cover Screw (4)	15C-30	15C-30
+*3	Fuel Pump-Gasket	16B-227	16B-227
+*4	Fuel Pump-Diaphragm	237-144	237-144
*5	Fuel Pump-Inlet Screen	95-233	95-188
*6	Fuel Inlet-Needle	34-216	34-216
*7	Fuel Inlet-Control Lever	155A-71	155A-26
8	Fuel Inlet-Fulcrum Pin	32-78	32-78
9	Fuel Inlet-Fulcrum Pin Retaining Screw	15B-345	15B-345
10	Fuel Inlet-Tension Spring	24B-299	24B-299
11	Metering-Cover	91-1009	91B-253
12	Metering-Cover Screw (4)	15C-19	15C-53
+*13	Metering-Diaphragm	237-653	237-686
+*14	Metering-Diaphragm Gasket	16B-226	16B-226
*15	Metering-By Pass Chamber Welch Plug (Large)	179-59	179-59
*16	Metering-Main Nozzle Welch Plug (Small)		
*17	Metering-Main Nozzle Screen		
18	Metering-Main Nozzle Screen Retaining Ring		
19	Metering-Nozzle Valve	363-518	363-656
20	Idle Speed-Adjustment Screw	15C-44	15B-330
21	Idle Speed-Adjustment Screw Spring		24B-298
B1	Idle Speed-Adjustment Screw Cup		
B6	Idle Speed-Adjustment Screw Retainer	55A-305	
22	Low Speed-Mixture Needle	43A-179	49B-5
23	Low Speed-Mixture Needle Spring	24B-331	
24	High Speed-Mixture Needle	43A-178	
25	High Speed-Mixture Needle Spring	24B-331	
26	High Speed-Governor Valve	361-545	
27	High Speed-Governor Valve Gasket	16B-204	
A4	Choke-Shaft & Lever		
A21	Choke-Shaft & Lever	26-1301	26-1308
28	Choke-Friction Spring		24B-281
29	Choke-Friction Ball		206-121
30	Choke-Shutter	27-331	27-374
31	Choke-Shutter Screw	15C-20	15C-20
B10	Choke-Shaft Return Spring	24C-267	
B17	Choke-Shaft E-Ring		
C3	Choke-Lever		
A5	Throttle-Shaft & Lever	13-2091	13-2109
A9	Throttle-Shaft & Lever		
32	Throttle-Return Spring	24C-29	24B-435
33	Throttle-Clip		
34	Throttle-Clip Retaining Screw		
35	Throttle-Shaft Washer		
36	Throttle-Shaft E-Ring	29-220	
37	Throttle-Shutter	14-445	14-471
38	Throttle-Shutter Screw	15C-20	15C-20
B3	Throttle-Shaft Sleeve	102-217	102-204
C2	Throttle-Lever		12B-436
B4	Throttle-Lever Retaining Screw		15B-348
		102-204	
49	Main Jet Seal Screw (2)		15C-14
50	Sealing Gasket		16B-184
	Repair Kit	RK-21HS	RK-26HS
	Diaphragm & Gasket Set	DG-3HS	DG-8HS

*Indicates contents of Repair Kit

+Indicates contents of Diaphragm & Gasket Set

Carburetor Model		HS-279D	HS-280A	HS-281A
Customer		Stihl	Stihl	Stihl
Equipment Model No.				
		4223	4205	4205
Venturi				
Ref. No.	Part Name			
1	Fuel Pump-Cover	91-786	91-761	91-761
2	Fuel Pump-Cover Screw (4)	15C-30	15C-30	15C-30
+*3	Fuel Pump-Gasket	16B-227	16B-227	16B-227
+*4	Fuel Pump-Diaphragm	237-143	237-144	237-144
*5	Fuel Pump-Inlet Screen	95-233	95-233	95-233
*6	Fuel Inlet-Needle	34-219	34-219	34-219
*7	Fuel Inlet-Control Lever	155A-71	155A-71	155A-71
8	Fuel Inlet-Fulcrum Pin	32-78	32-78	32-78
9	Fuel Inlet-Fulcrum Pin Retaining Screw	15B-345	15B-345	15B-345
10	Fuel Inlet-Tension Spring	24B-345	24B-299	24B-299
11	Metering-Cover	91-1006	91-1009	91-1009
12	Metering-Cover Screw (4)	15C-19	15C-19	15C-19
+*13	Metering-Diaphragm	237-653	237-653	237-653
+*14	Metering-Diaphragm Gasket	16B-226	16B-226	16B-226
*15	Metering-By Pass Chamber Welch Plug (Large)	179-59	179-59	179-59
*16	Metering-Main Nozzle Welch Plug (Small)			
*17	Metering-Main Nozzle Screen			
18	Metering-Main Nozzle Screen Retaining Ring			
19	Metering-Nozzle Valve	363-643	363-626	363-626
20	Idle Speed-Adjustment Screw	15C-44	15C-44	15C-44
21	Idle Speed-Adjustment Screw Spring			
B1	Idle Speed-Adjustment Screw Cup			
B6	Idle Speed-Adjustment Screw Retainer	55A-305	55A-305	55A-305
22	Low Speed-Mixture Needle	43A-176	43A-187	43A-187
23	Low Speed-Mixture Needle Spring	24B-331	24C-270	24C-270
24	High Speed-Mixture Needle		43A-188	43A-188
25	High Speed-Mixture Needle Spring		24C-270	24C-270
26	High Speed-Governor Valve			
27	High Speed-Governor Valve Gasket		16B-204	16B-204
A4	Choke-Shaft & Lever			
A21	Choke-Shaft & Lever	26A-215	26-1301	26-1301
28	Choke-Friction Spring			
29	Choke-Friction Ball			
30	Choke-Shutter	27-372	27-331	27-331
31	Choke-Shutter Screw	15C-20	15C-20	15C-20
B10	Choke-Shaft Return Spring		24C-267	24C-267
A5	Throttle-Shaft & Lever	13-2112	13-2111	13-2111
A9	Throttle-Shaft & Lever			
32	Throttle-Return Spring	24C-265	24C-29	24C-29
33	Throttle-Clip			
34	Throttle-Clip Retaining Screw			
35	Throttle-Shaft Washer	78A-226	78A-226	78A-226
36	Throttle-Shaft E-Ring	29-220	29-220	29-220
37	Throttle-Shutter	14A-58	14-445	14-445
38	Throttle-Shutter Screw	15C-20	15C-20	15C-20
B3	Throttle-Shaft Sleeve	102-219	102-217	102-217
C2	Throttle-Lever	12B-448		
B4	Throttle-Lever Retaining Screw	15B-348		
*39	Flange Gasket			
40	O-Ring		44-350	44-350
	Adjustment Limiter Module		198-584	198-584
45	Adjustment Cap		318-32	318-32
46	Remote Main Jet		49B-4	49B-4
47	Part Throttle Jet	363-625	363-625	363-625
	Repair Kit	RK-28HS	RK-29HS	RK-29HS
	Diaphragm & Gasket Set	DG-7HS	DG-3HS/T	DG-3HS/T

*Indicates contents of Repair Kit

+Indicates contents of Diaphragm & Gasket Set

Carburetor Model		HS-284E	HS-285A	HS-286A
Customer		Wacker	Wacker	Dolmar
Equipment Model No.				
		500/600	700L	PS6000
Venturi		13.0MM	14.3MM	5/8
Ref. No.	Part Name			
1	Fuel Pump-Cover	91A-273	91A-273	91-1005
2	Fuel Pump-Cover Screw (4)	15C-30	15C-30	15C-30
+*3	Fuel Pump-Gasket	16B-227	16B-227	16B-227
+*4	Fuel Pump-Diaphragm	237-144	237-144	237-144
*5	Fuel Pump-Inlet Screen	95-188	95-188	95-177
*6	Fuel Inlet-Needle	34-216	34-216	34-219
*7	Fuel Inlet-Control Lever	155A-26	155A-26	155A-26
8	Fuel Inlet-Fulcrum Pin	32-78	32-78	32-78
9	Fuel Inlet-Fulcrum Pin Retaining Screw	15B-345	15B-345	15B-345
10	Fuel Inlet-Tension Spring	24B-299	24B-299	24B-435
11	Metering-Cover	91B-253	91B-253	91B-253
12	Metering-Cover Screw (4)	15C-53	15C-53	15C-19
+*13	Metering-Diaphragm	237-686	237-686	237-601
+*14	Metering-Diaphragm Gasket	16B-226	16B-226	16B-226
*15	Metering-By Pass Chamber Welch Plug (Large)	179-59	179-59	179-59
*16	Metering-Main Nozzle Welch Plug (Small)			
*17	Metering-Main Nozzle Screen			
18	Metering-Main Nozzle Screen Retaining Ring			
19	Metering-Nozzle Valve	363-656	363-598	363-626
20	Idle Speed-Adjustment Screw	15B-330	15B-330	15C-21
21	Idle Speed-Adjustment Screw Spring	24B-298	24B-298	
B1	Idle Speed-Adjustment Screw Cup			
B6	Idle Speed Adjustment Screw Spring			206-123
22	Low Speed-Mixture Needle	49B-5	49B-5	43A-187
23	Low Speed-Mixture Needle Spring			24C-270
24	High Speed-Mixture Needle		49B-80	43A-206
25	High Speed-Mixture Needle Spring			24C-270
26	High Speed-Governor Valve			
27	High Speed-Governor Valve Gasket	16B-184		
A4	Choke-Shaft & Lever			
A2	Choke-Shaft & Lever	26-1308	26-1308	
28	Choke-Friction Spring	24B-281	24B-281	
29	Choke-Friction Ball	206-121	206-121	
30	Choke-Shutter	27-374	27-374	
31	Choke-Shutter Screw	15C-20	15C-20	
°B18	Choke - Valve Inlet Needle			34-224
°B14	Choke - Valve Sleeve			62A-114
°B15	Choke - Valve Tension Spring			24C-228
	Choke - Valve Retaining Screw			15B-446
	Choke -			
A16	Throttle-Shaft & Lever	13-2109	13-2109	
A20	Throttle-Shaft & Lever			13-1956
32	Throttle-Return Spring	24B-435	24B-435	24C-29
37	Throttle-Shutter	14-471	14-471	14-431
38	Throttle-Shutter Screw	15C-20	15C-20	15C-20
B3	Throttle-Shaft Sleeve	102-204	102-204	
C2	Throttle-Lever	12B-436	12B-436	
B4	Throttle-Lever Retaining Screw	15B-348	15B-348	
	Low/High Speed - Mixture Needle O-Ring			44-350
	Adjustment Limiter Module			198-402
	Adjustment Limiter Cap (2)			318-32
	Remote Fixed Jet			49B-4
		15C-14	15C-14	
	Choke-Valve			392-506
	Repair Kit	RK-26HS	RK-26HS	RK-23HS
	Diaphragm & Gasket Set	DG-8HS	DG-8HS	DG-5HS/T

*Indicates contents of Repair Kit

+Indicates contents of Diaphragm & Gasket Set

Carburetor Model		HS-294A	HS-295A	HS-296A
Customer		Dolmar	Dolmar	Husqvarna
Equipment Model No.		PS-9010	PS-9010	Husky H385
Venturi		23/32" 18.3MM	23/32" 18.3MM	11/16" 17.46MM
Ref. No.	Part Name			
1	Fuel Pump-Cover	91-988	91-988	91-1008
2	Fuel Pump-Cover Screw (4)	15C30	15C30	15C30
+*3	Fuel Pump-Gasket	16B-227	16B-227	16B-227
+*4	Fuel Pump-Diaphragm	237-144	237-144	237-144
*5	Fuel Pump-Inlet Screen	95-177	95-177	95-233
*6	Fuel Inlet-Needle	34-219	34-219	34-219
*7	Fuel Inlet-Control Lever	155A26	155A26	155A-26
8	Fuel Inlet-Fulcrum Pin	32-78	32-78	32-78
9	Fuel Inlet-Fulcrum Pin Retaining Screw	15B345	15B345	15B345
10	Fuel Inlet-Tension Spring	24B-323	24B-323	24B-299
B5	Fuel Inlet-Seat			
11	Metering-Cover	91A-352	91A-352	91B-223
12	Metering-Cover Screw (4)	15C-19	15C-19	15C-19
+*13	Metering-Diaphragm	237-601	237-601	237-601
+*14	Metering-Diaphragm Gasket	16B-226	16B-226	16B-226
*15	Metering-By Pass Chamber Welch Plug (Large)	179-59	179-59	179-62
*16	Metering-Main Nozzle Welch Plug (Small)			
*17	Metering-Main Nozzle Screen			
18	Metering-Main Nozzle Screen Retaining Ring			
19	Metering-Nozzle Valve	363-598	363-598	363-598
20	Idle Speed-Adjustment Screw	15C-44	15C-58	15C-21
21	Idle Speed-Adjustment Screw Spring			
B1	Idle Speed-Adjustment Screw Cup	55A-305	55A-305	55A-305
B6	Idle Speed Adjustment Screw Spring			
22	Low Speed-Mixture Needle	43A-176	43A-187	43A-211
23	Low Speed-Mixture Needle Spring	24B-331	24C-270	24C-280
24	High Speed-Mixture Needle	43A-177	43A-188	43A-210
25	High Speed-Mixture Needle Spring	24B-331	24C-270	24C-280
A3	Choke-Shaft & Lever			13-2127
A4	Choke-Shaft & Lever	26-1311	26-1311	
A8	Choke-Shaft & Lever	13-2076	13-2076	
A23	Choke-Shaft & Lever			26-1310
28	Choke-Friction Spring	24B-281	24B-281	24B-281
29	Choke-Friction Ball	206-121	206-121	206-121
30	Choke-Shutter	27-331	27-331	27-331
31	Choke-Shutter Screw	15C-20	15C-20	15C-20
B2	Choke-Shaft Cover			
B3	Choke-Shaft Sleeve	102-204	102-204	102-217
B8	Choke-Shaft O-Ring	44-350	44-350	44-350
B10	Choke-Shaft Return Spring			24C-279
B17	Choke-Shaft E-Ring	29-223	29-223	
C3	Choke-Lever			25-498
C5	Choke-Lever			25-457
B3	Throttle-Shaft Sleeve			102-208
B4	Throttle-Lever Retaining Screw			15B-348
32	Throttle-Return Spring	24C-29	24C-29	24C-281
33	Throttle-Clip			
34	Throttle-Clip Retaining Screw			
35	Throttle-Shaft Washer	78A-226	78A-226	78A-226
36	Throttle-Shaft E-Ring	29-220	29-220	29-220
37	Throttle-Shutter	14A-23	14A-23	14A-67
38	Throttle-Shutter Screw	15C-20	15C-20	15C-20
*39	Flange Gasket			
40	O-Ring	44-350	44-350	
	Repair Kit	RK-34HS	RK-34HS	RK-32HS
	Diaphragm & Gasket Set	DG-5HS/T	DG-5HS/T	DG-5HS/T

*Indicates contents of Repair Kit

+Indicates contents of Diaphragm & Gasket Set

Carburetor Model		HS-297A	HS-298A
Customer		Husqvarna	Husqvarna
Equipment Model No.		Husky J 2095	Husky H395
Venturi		11/16" 17.46MM	11/16" 17.46MM
Ref. No.	Part Name		
1	Fuel Pump-Cover	91-761	91-1008
2	Fuel Pump-Cover Screw (4)	15C-30	15C-30
+*3	Fuel Pump-Gasket	16B-227	16B-227
+*4	Fuel Pump-Diaphragm	237-144	237-144
*5	Fuel Pump-Inlet Screen	95-233	95-233
*6	Fuel Inlet-Needle	34-219	34-219
*7	Fuel Inlet-Control Lever	155A-26	155A-26
8	Fuel Inlet-Fulcrum Pin	32-78	32-78
9	Fuel Inlet-Fulcrum Pin Retaining Screw	15B-345	15B-345
10	Fuel Inlet-Tension Spring	24B-299	24B-299
B5	Fuel Inlet-Seat		
11	Metering-Cover	91A-274	91B-223
12	Metering-Cover Screw (4)	15C-19	15C-19
+*13	Metering-Diaphragm	237-601	237-601
+*14	Metering-Diaphragm Gasket	16B-226	16B-226
*15	Metering-By Pass Chamber Welch Plug (Large)	179-62	179-62
*16	Metering-Main Nozzle Welch Plug (Small)		
*17	Metering-Main Nozzle Screen		
18	Metering-Main Nozzle Screen Retaining Ring		
19	Metering-Nozzle Valve	363-598	363-598
20	Idle Speed-Adjustment Screw	15C-21	15C-55
21	Idle Speed-Adjustment Screw Spring	55A-305	
B1	Idle Speed-Adjustment Screw Cup		55A-305
B6	Idle Speed Adjustment Screw Spring		
22	Low Speed-Mixture Needle	43A-211	43A-211
23	Low Speed-Mixture Needle Spring	24C-280	24C-280
24	High Speed-Mixture Needle	43A-210	43A-210
25	High Speed-Mixture Needle Spring	24C-280	24C-280
26	High Speed-Governor Valve		
27	High Speed-Governor Valve Gasket		
B7	High Speed-Sealing Screw Gasket	78A-352	
A1	Choke-Shaft & Lever		
A2	Choke-Shaft & Lever		
A3	Choke-Shaft & Lever	13-2049	13-2127
A23	Choke-Shaft & Lever	26-1274	26-1310
28	Choke-Friction Spring		24B-281
29	Choke-Friction Ball		206-121
30	Choke-Shutter	27-331	27-331
31	Choke-Shutter Screw	15C-20	15C-20
B2	Choke-Shaft Cover		
B3	Choke-Shaft Sleeve		102-217
B4		15B-348	15B-348
B8	Choke-Shaft O-Ring	44-350	44-350
B10	Choke-Shaft Return Spring	24C-141	24C-279
C2	Choke-Lever		
C3	Choke-Lever	25-469	25-498
C4			
C5	Choke-Lever	25-457	25-457
B3	Throttle-Shaft Sleeve		102-208
32	Throttle-Return Spring	24C-239	24C-281
33	Throttle-Clip		
34	Throttle-Clip Retaining Screw		
35	Throttle-Shaft Washer	78A-280	78A-226
36	Throttle-Shaft E-Ring	29-220	29-220
37	Throttle-Shutter	14A-67	14A-67
38	Throttle-Shutter Screw	15C-20	15C-20
	Repair Kit	RK-32HS	RK-32HS
	Diaphragm & Gasket Set	DG-5HS/T	DG-5HS/T

*Indicates contents of Repair Kit

+Indicates contents of Diaphragm & Gasket Set