



TILLOTSON LTD., CLASH INDUSTRIAL ESTATE,
TRALEE, CO. KERRY, IRELAND

PHONE: +353 66 7121911 FAX: +353 66 7124503

e-mail: sales@tillotson.ie



PARTS LIST





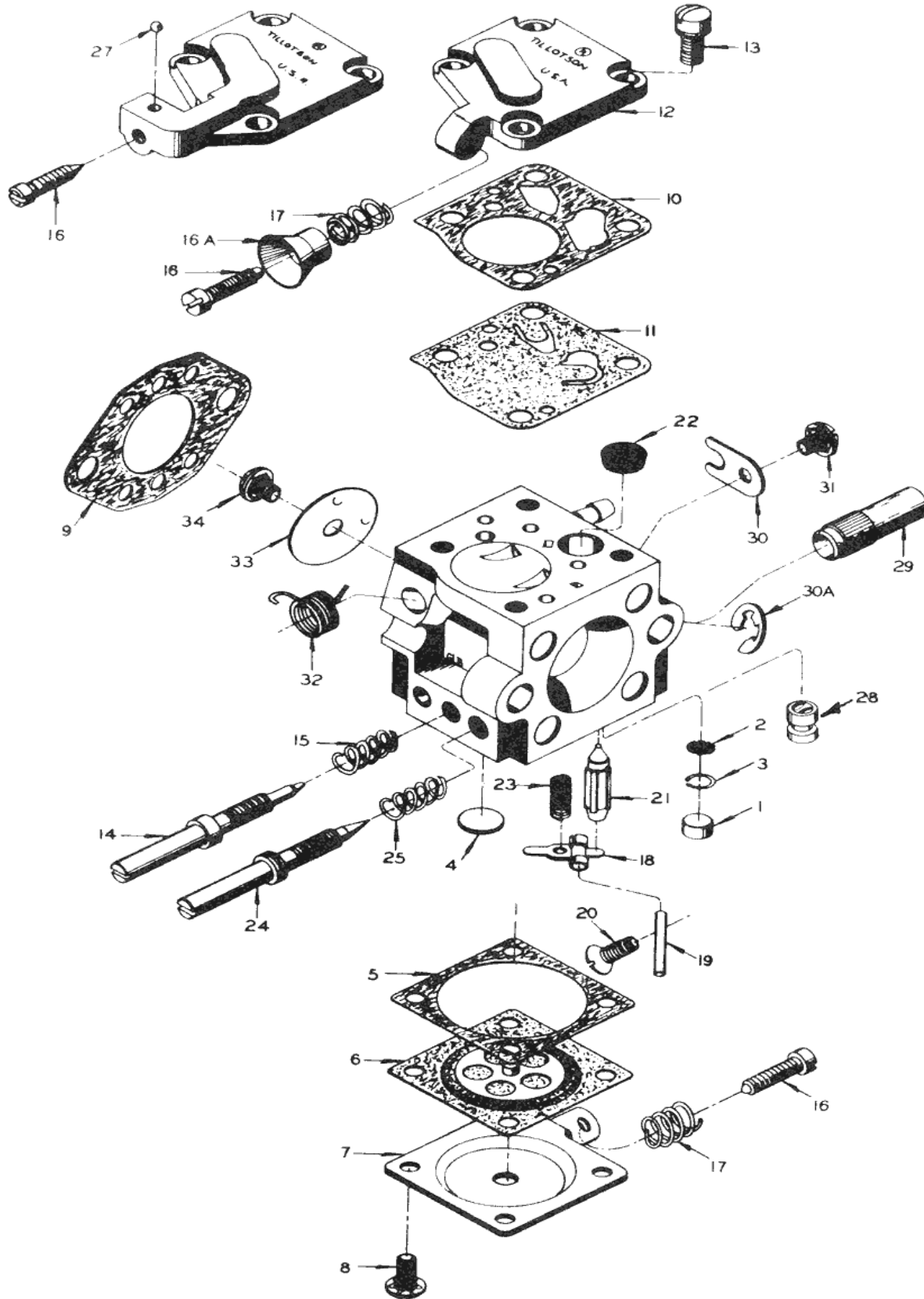









Last update: JULY 2000

Illustration of basic parts standard throughout HU series carburettor.
For individual model listing see following pages.











Parts illustrated are typical in appearance
and may not look exactly like the part required

SHAFT AND LEVER ASSEMBLIES

| | | | | |
|---|---|---|---|---|
|  <p>A1</p> |  <p>A2</p> |  <p>A3</p> |  <p>A4</p> |  <p>A5</p> |
|  <p>A6</p> |  <p>A7</p> |  <p>A8</p> |  <p>A9</p> |  <p>A10</p> |
|  <p>A11</p> |  <p>A12</p> |  <p>A13</p> |  <p>A14</p> |  <p>A15</p> |

MISCELLANEOUS PARTS

| | | | | |
|--|--|--|--|--|
|  <p>B1</p> |  <p>B2</p> |  <p>B3</p> |  <p>B4</p> |  <p>B5</p> |
|  <p>B6</p> |  <p>B7</p> |  <p>B8</p> |  <p>B9</p> | |



HU SERIES

| Carburetor Model | | HU-100D | HU-103B | HU-104B |
|---------------------|---|-------------------|-------------------|-------------------|
| Customer | | Tecumseh Products | Tecumseh Products | Tecumseh Products |
| Equipment Model No. | | | | |
| Venturi | | | | |
| Ref. No. | Part Name | | | |
| *4 | Body Channel Welch Plug | 179-62 | 179-62 | 179-62 |
| *+5 | Diaphragm Gasket | 16B-383 | 16B-383 | 16B-383 |
| *+6 | Diaphragm | 237-684 | 237-684 | 237-684 |
| 7 | Diaphragm Cover | 91A-311 | 91A-311 | 91A-311 |
| 8 | Diaphragm Cover Ret. Screw & Lockwasher (4) | 15C-19 | 15C-19 | 15C-19 |
| 9 | Flange Gasket | | | |
| *+10 | Fuel Pump Gasket | 16B-247 | 16B-247 | 16B-247 |
| *+11 | Fuel Pump Diaphragm | 237-163 | 237-163 | 237-163 |
| 12 | Fuel Pump Body | 91A-467 | 91A-467 | 91A-467 |
| 13 | Fuel Pump Body Ret. Screw & Lockwasher (4) | 15B-393 | 15B-393 | 15B-393 |
| 14 | Idle Mixture Screw | 43A-144 | 43A-144 | 43A-144 |
| 15 | Idle Mixture Screw Spring | 24B-331 | 24B-331 | 24B-331 |
| 16 | Idle Speed Screw | 15C-1 | 15C-1 | 15C-1 |
| 17 | Idle Speed Screw Spring | | | |
| *18 | Inlet Control Lever | 155A-29 | 155A-29 | 155A-29 |
| 19 | Inlet Fulcrum Pin | 32-80 | 32-80 | 32-80 |
| 20 | Inlet Fulcrum Pin Ret. Screw | 15B-329 | 15B-329 | 15B-329 |
| *21 | Inlet Needle | 34-219 | 34-219 | 34-219 |
| 22 | Inlet Screen | 95-177 | 95-177 | 95-177 |
| 23 | Inlet Tension Spring | 24C-259 | 24C-259 | 24C-259 |
| 24 | High Speed Mixture Screw | | | |
| 25 | High Speed Mixture Screw Spring | | | |
| 28 | Nozzle Check Valve | 363-559 | 363-559 | 363-559 |
| 30 | Throttle Shaft Clip | 29-218 | 29-218 | 29-218 |
| 31 | Throttle Shaft Clip Ret. Screw | 15C-20 | 15C-20 | 15C-20 |
| 32 | Throttle Return Spring | 24C-251 | 24C-251 | 24C-251 |
| 33 | Throttle Shutter | 14-432 | 14-432 | 14-432 |
| 34 | Throttle Shutter Screw & Lockwasher | 15C-20 | 15C-20 | 15C-20 |
| | Throttle Pawl Lever | 12B-422 | 12B-428 | 12B-428 |
| | Throttle Pawl Lever Screw | 15B-348 | 15B-348 | 15B-348 |
| | Throttle Shaft & Lever | 13-2082 | 13-2082 | 13-2082 |
| | High Speed Jet Sealing Cup | | | |
| | High Speed Jet | 49A-494 | 49A-485 | 49A-494 |
| | Washer | 78A-280 | 78A-357 | 78A-280 |
| | Foam Shaft Seals | | | |
| | Felt Shaft Seals | 44-347 | 44-347 | 44-347 |
| | Choke Shaft Assembly | | 26-1293 | |
| | Choke Friction Spring | | 24B-281 | |
| | Choke Friction Ball | | 206-121 | |
| | Repair Kit | RK-21HU | RK-21HU | RK-21HU |
| | Diaphragm & Gasket Set | DG-4HU | DG-4HU | DG-4HU |

*Indicates contents of Repair Kit
 +Indicates contents of Diaphragm & Gasket Set



HU SERIES

| Carburetor Model | | HU-106A | HU-107E | HU-108D |
|---------------------|---|-------------------|-------------------|---------|
| Customer | | Tecumseh Products | Tecumseh Products | |
| Equipment Model No. | | | | |
| Venturi | | | | |
| Ref. No. | Part Name | | | |
| *4 | Body Channel Welch Plug | 179-62 | 179-62 | 179-62 |
| *+5 | Diaphragm Gasket | 16B-383 | 16B-383 | 16B-383 |
| *+6 | Diaphragm | 237-684 | 237-684 | 237-684 |
| 7 | Diaphragm Cover | 91A-311 | 91A-311 | 91A-311 |
| 8 | Diaphragm Cover Ret. Screw & Lockwasher (4) | 15C-19 | 15C-19 | 15C-19 |
| 9 | Flange Gasket | | | |
| *+10 | Fuel Pump Gasket | 16B-247 | 16B-247 | 16B-247 |
| *+11 | Fuel Pump Diaphragm | 237-163 | 237-163 | 237-163 |
| 12 | Fuel Pump Body | 91B-238 | 91A-467 | 91A-467 |
| 13 | Fuel Pump Body Ret. Screw & Lockwasher (4) | 15B-353 | 15B-353 | 15B-353 |
| 14 | Idle Mixture Screw | 43A-144 | 43A-144 | 43A-144 |
| 15 | Idle Mixture Screw Spring | 24B-331 | 24B-331 | 24B-331 |
| 16 | Idle Speed Screw | 15C-3 | 15C-1 | 15C-1 |
| 17 | Idle Speed Screw Spring | 24C-15 | | |
| *18 | Inlet Control Lever | 155A-29 | 155A-29 | 155A-29 |
| 19 | Inlet Fulcrum Pin | 32-80 | 32-80 | 32-80 |
| 20 | Inlet Fulcrum Pin Ret. Screw | 15B-329 | 15B-329 | 15B-329 |
| *21 | Inlet Needle | 34-219 | 34-219 | 34-219 |
| 22 | Inlet Screen | 95-177 | 95-177 | 95-177 |
| 23 | Inlet Tension Spring | 24C-259 | 24C-259 | 24C-259 |
| 24 | High Speed Mixture Screw | | | |
| 25 | High Speed Mixture Screw Spring | | | |
| 28 | Nozzle Check Valve | 363-559 | 363-559 | 363-559 |
| 30 | Throttle Shaft Clip | 29-218 | 29-218 | 29-218 |
| 31 | Throttle Shaft Clip Ret. Screw | 15C-20 | 15C-34 | 15C-34 |
| 32 | Throttle Return Spring | 24C-261 | 24C-251 | 24C-251 |
| 33 | Throttle Shutter | 14-432 | 14-432 | 14-432 |
| 34 | Throttle Shutter Screw & Lockwasher | 15C-20 | 15C-20 | 15C-20 |
| | Throttle Pawl Lever | 12B-422 | | |
| | Throttle Pawl Lever Screw | 15B-348 | | |
| | Throttle Shaft & Lever | 13-2082 | 13-2094 | 13-2094 |
| | Throttle Shaft Clip Screw Spacer | | 78A-356 | 78A-356 |
| | High Speed Jet Sealing Cup | | 80-332 | 80-332 |
| | High Speed Jet | 49A-494 | 49A-494 | 49A-494 |
| | Washer | 78A-280 | 78A-358 | 78A-358 |
| | Foam Shaft Seals | | | |
| | Felt Shaft Seals | 44-347 | 44-351 | 44-349 |
| | Choke Shaft Assembly | | | |
| | Choke Friction Spring | | | |
| | Choke Friction Ball | | | |
| | Repair Kit | RK-21HU | RK-21HU | RK-21HU |
| | Diaphragm & Gasket Set | DG-4HU | DG-4HU | DG-4HU |

*Indicates contents of Repair Kit
 +Indicates contents of Diaphragm & Gasket Set



HU SERIES

| Carburetor Model | | HU-108D | HU-109A | HU-110A |
|---------------------|---|-------------------|-------------------|-------------------|
| Customer | | Tecumseh Products | Tecumseh Products | Tecumseh Products |
| Equipment Model No. | | | | |
| Venturi | | | | |
| Ref. No. | Part Name | | | |
| *4 | Body Channel Welch Plug | 179-62 | 179-62 | 179-62 |
| *+5 | Diaphragm Gasket | 16B-383 | 16B-383 | 16B-383 |
| *+6 | Diaphragm | 237-684 | 237-684 | 237-684 |
| 7 | Diaphragm Cover | 91A-311 | 91A-311 | 91A-311 |
| 8 | Diaphragm Cover Ret. Screw & Lockwasher (4) | 15C-19 | 15C-19 | 15C-19 |
| 9 | Flange Gasket | | | |
| *+10 | Fuel Pump Gasket | 16B-247 | 16B-247 | 16B-247 |
| *+11 | Fuel Pump Diaphragm | 237-163 | 237-163 | 237-163 |
| 12 | Fuel Pump Body | 91A-467 | 91A-467 | 91A-467 |
| 13 | Fuel Pump Body Ret. Screw & Lockwasher (4) | 15B-393 | 15B-353 | 15B-393 |
| 14 | Idle Mixture Screw | 43A-144 | 43A-144 | 43A-144 |
| 15 | Idle Mixture Screw Spring | 24B-331 | 24B-331 | 24B-331 |
| 16 | Idle Speed Screw | 15C-1 | 15C-1 | 15C-1 |
| 17 | Idle Speed Screw Spring | | | |
| *18 | Inlet Control Lever | 155A-29 | 155A-29 | 155A-29 |
| 19 | Inlet Fulcrum Pin | 32-80 | 32-80 | 32-80 |
| 20 | Inlet Fulcrum Pin Ret. Screw | 15B-329 | 15B-329 | 15B-329 |
| *21 | Inlet Needle | 34-219 | 34-219 | 34-219 |
| 22 | Inlet Screen | 95-177 | 95-177 | 95-177 |
| 23 | Inlet Tension Spring | 24C-259 | 24C-259 | 24C-259 |
| 24 | High Speed Mixture Screw | | | |
| 25 | High Speed Mixture Screw Spring | | | |
| 28 | Nozzle Check Valve | 363-559 | 363-559 | 363-559 |
| 30 | Throttle Shaft Clip | 29-218 | 29-218 | 29-218 |
| 31 | Throttle Shaft Clip Ret. Screw | 15C-34 | 15C-34 | 15C-34 |
| 32 | Throttle Return Spring | 24C-251 | 24C-261 | 24C-261 |
| 33 | Throttle Shutter | 14-432 | 14-432 | 14-432 |
| 34 | Throttle Shutter Screw & Lockwasher | 15C-20 | 15C-20 | 15C-20 |
| | Throttle Pawl Lever | | | |
| | Throttle Pawl Lever Screw | | | |
| | Throttle Shaft & Lever | 13-2094 | 13-2094 | 13-2094 |
| | Throttle Shaft Clip Screw Spacer | 78A-356 | 78A-356 | 78A-356 |
| | High Speed Jet Sealing Cup | 80-332 | | |
| | High Speed Jet | 49A-494 | 49A-494 | 49A-494 |
| | Washer | 78A-358 | 78A-280 | 78A-280 |
| | Foam Shaft Seals | | | |
| | Felt Shaft Seals | 44-349 | 44-347 | 44-347 |
| | Choke Shaft Assembly | | | |
| | Choke Friction Spring | | | |
| | Choke Friction Ball | | | |
| | Repair Kit | RK-21HU | RK-21HU | RK-21HU |
| | Diaphragm & Gasket Set | DG-4HU | DG-4HU | DG-4HU |

*Indicates contents of Repair Kit

+Indicates contents of Diaphragm & Gasket Set



HU SERIES

| Carburetor Model | | HU-112E | HU-113A | HU-114E |
|---------------------|---|-------------------|-------------------|-------------------|
| Customer | | Tecumseh Products | Tecumseh Products | Tecumseh Products |
| Equipment Model No. | | | | |
| Venturi | | | | |
| Ref. No. | Part Name | | | |
| *4 | Body Channel Welch Plug | 179-62 | 179-62 | 179-62 |
| *+5 | Diaphragm Gasket | 16B-383 | 16B-383 | 16B-383 |
| *+6 | Diaphragm | 237-684 | 237-684 | 237-684 |
| 7 | Diaphragm Cover | 91A-311 | 91A-311 | 91A-311 |
| 8 | Diaphragm Cover Ret. Screw & Lockwasher (4) | 15C-19 | 15C-19 | 15C-19 |
| 9 | Flange Gasket | 16B-248 | 16B-248 | 16B-248 |
| *+10 | Fuel Pump Gasket | 16B-247 | 16B-247 | 16B-247 |
| *+11 | Fuel Pump Diaphragm | 237-163 | 237-163 | 237-163 |
| 12 | Fuel Pump Body | 91-981 | 91-981 | 91-981 |
| 13 | Fuel Pump Body Ret. Screw & Lockwasher (4) | 15B-393 | 15B-393 | 15B-393 |
| 14 | Idle Mixture Screw | 43A-194 | 43A-144 | 43A-194 |
| 15 | Idle Mixture Screw Spring | 24C-270 | 24B-331 | 24C-270 |
| 16 | Idle Speed Screw | | 15C-1 | |
| 17 | Idle Speed Screw Spring | | | |
| *18 | Inlet Control Lever | 155A-29 | 155A-29 | 155A-29 |
| 19 | Inlet Fulcrum Pin | 32-80 | 32-80 | 32-80 |
| 20 | Inlet Fulcrum Pin Ret. Screw | 15B-329 | 15B-329 | 15B-329 |
| *21 | Inlet Needle | 34-219 | 34-219 | 34-219 |
| 22 | Inlet Screen | 95-177 | 95-177 | 95-177 |
| 23 | Inlet Tension Spring | 24C-259 | 24C-259 | 24C-259 |
| 24 | High Speed Mixture Screw | | 43A-120 | |
| 25 | High Speed Mixture Screw Spring | | 24B-449 | |
| 28 | Nozzle Check Valve | 363-645 | 363-559 | 363-645 |
| 30 | Throttle Shaft Clip | 29-218 | 29-218 | 29-218 |
| 31 | Throttle Shaft Clip Ret. Screw | 15C-34 | 15C-34 | 15C-34 |
| 32 | Throttle Return Spring | 24C-251 | 24C-251 | 24C-251 |
| 33 | Throttle Shutter | 14-432 | 14-432 | 14-432 |
| 34 | Throttle Shutter Screw & Lockwasher | 15C-20 | 15C-20 | 15C-20 |
| | Throttle Shaft & Lever | 13-2094 | 13-2106 | 13-2094 |
| | High Speed Jet Sealing Cup | 80-332 | | 80-332 |
| | Washer | 78A-358 | 78A-358 | 78A-358 |
| | Module Clamp Screw | 15C-57 | | 15C-57 |
| | Throttle Shaft Clip Screw Spacer | 78A-356 | 78A-356 | 78A-356 |
| | Adjustment Limiter Module | 198-407 | | 198-407 |
| | Adjustment Limiter Cap (2) | 318-35 | | 318-35 |
| | Foam Shaft Seals | 44-351 | 44-351 | 44-351 |
| | Repair Kit | RK-21HU | RK-21HU | RK-21HU |
| | Diaphragm & Gasket Set | DG-4HU | DG-4HU | DG-4HU |

*Indicates contents of Repair Kit
 +Indicates contents of Diaphragm & Gasket Set



HU SERIES

| Carburetor Model | | HU-115B | HU-116B | HU-117A |
|---------------------|---|--------------|--------------|---------|
| Customer | | Sachs-Dolmar | Sachs-Dolmar | Alpina |
| Equipment Model No. | | | PS115i | 540/600 |
| Venturi | | | | |
| Ref. No. | Part Name | | | |
| *4 | Body Channel Welch Plug | 179-62 | 179-62 | 179-62 |
| *+5 | Diaphragm Gasket | 16B-383 | 16B-246 | 16B-383 |
| *+6 | Diaphragm | 237-684 | 237-604 | 237-684 |
| 7 | Diaphragm Cover | 91B-236 | 91B-236 | 91A-311 |
| 8 | Diaphragm Cover Ret. Screw & Lockwasher (4) | 15C-19 | 15C-19 | |
| 9 | Flange Gasket | | | 16B-248 |
| *+10 | Fuel Pump Gasket | 16B-247 | 16B-247 | 16B-247 |
| *+11 | Fuel Pump Diaphragm | 237-153 | 237-153 | 237-153 |
| 12 | Fuel Pump Body | 91A-467 | 91A-467 | 91-915 |
| 13 | Fuel Pump Body Ret. Screw & Lockwasher (4) | 15C-30 | 15B-393 | 15B-393 |
| 14 | Idle Mixture Screw | 43A-118 | 43A-207 | 43A-207 |
| 15 | Idle Mixture Screw Spring | 24B-449 | 24C-270 | 24C-270 |
| 16 | Idle Speed Screw | 15B-468 | | 15C-1 |
| 17 | Idle Speed Screw Spring | | | |
| *18 | Inlet Control Lever | 155A-29 | | 155A-29 |
| 19 | Inlet Fulcrum Pin | 32-80 | | 32-80 |
| 20 | Inlet Fulcrum Pin Ret. Screw | 15B-329 | | 15B-329 |
| *21 | Inlet Needle | 34-219 | | 34-219 |
| 22 | Inlet Screen | 95-188 | | 95-177 |
| 23 | Inlet Tension Spring | 24B-389 | | 24B-369 |
| 24 | High Speed Mixture Screw | 43A-120 | | 43A-208 |
| 25 | High Speed Mixture Screw Spring | 24B-449 | | 24C-270 |
| 28 | Nozzle Check Valve | 363-646 | 363-657 | 363-648 |
| 30 | Throttle Shaft Clip | | | |
| 31 | Throttle Shaft Clip Ret. Screw | | | |
| 32 | Throttle Return Spring | 24C-276 | 24C-248 | 24C-248 |
| 33 | Throttle Shutter | 14-423 | 14-432 | 14A-47 |
| 34 | Throttle Shutter Screw & Lockwasher | 15C-20 | 15C-20 | 15C-20 |
| | Throttle Lever Roll Pin | 62A-114 | | |
| | Throttle Return Spring Washers (2) | 102-217 | 102-217 | 102-217 |
| | Choke Lever (Blue Plastic) | 25-499 | | |
| | Choke Valve 'E' Clip | 55A-223 | | |
| | Choke Injection Assembly | 392-508 | 392-504 | |
| | Choke Return Spring | 24C-277 | | |
| | Adjustment Limiter Module | | 198-407 | 198-407 |
| | Adjustment Limiter Cap (2) | | 318-35 | 318-35 |
| A12 | Throttle Shaft & Lever | | | |
| A13 | Throttle Shaft & Lever | 13-2121 | 13-2083 | 13-2122 |
| B1 | Throttle Shaft | | | |
| B2 | Throttle Lever Assembly | | | |
| B3 | Throttle Lever Ret. Screw | 15B-329 | 15B-348 | |
| B4 | High Speed Mixture 'O' Ring (2) | 44-350 | 44-350 | 44-350 |
| B5 | Throttle Wire Connection | | | |
| B6 | Throttle Wire Connection Ret. Clip | | | |
| B7 | Throttle Lever | 12B-446 | 155A-68 | |
| B8 | Throttle Lever | | | |
| B9 | Throttle Lever | | | |
| 16A | Idle Speed Screw Cup | | | |
| 30A | Throttle Shaft Ret. Ring | | 29-220 | 29-220 |
| 32A | Throttle Return Spring Screw | | | |
| | Repair Kit | RK-23HU | RK-15HU | RK-22HU |
| | Diaphragm & Gasket Set | DG-6HU | DG-2HU | DG-6HU |

*Indicates contents of Repair Kit

+Indicates contents of Diaphragm & Gasket Set

