



Owner's Manual
MODELS: TPP-212E TPP-212EE
TPP-196R



For Warranty Matters, Call Toll free: 1-866-591-8921
For tuning service, contact your local dealer or sales@tillotson.ie

⚠ WARNING

READ AND FOLLOW ALL SAFETY RULES AND INSTRUCTIONS IN THIS MANUAL BEFORE ATTEMPTING TO OPERATE THIS MACHINE. FAILURE TO COMPLY WITH THESE INSTRUCTIONS MAY RESULT IN PERSONAL INJURY.

Diagrams within this manual may not be drawn proportionally. Due to continuing improvements, actual product may differ slightly from the product described herein.

SAFETY REFERENCES

The safety alert symbol  is used to identify safety information about hazards that can result in personal injury. A signal word (DANGER, WARNING, or CAUTION) is used with the alert symbol to indicate the likelihood and the potential severity of injury. In addition, a hazard symbol may be used to represent the type of hazard.

 **DANGER** indicates a hazard which, if not avoided, **will result in death or serious injury.**

 **WARNING** indicates a hazard which, if not avoided, **could result in death or serious injury.**

 **CAUTION** indicates a hazard which, if not avoided, **might result in minor or moderate injury.**



CAUTION, when used **without** the alert symbol, indicates a situation that **could result in damage to the engine**

Table of Contents

Safety References	2
Features and Controls	3
Safety	4
Operation	5
How to Start the Engine.....	5
How to Stop the Engine.....	6
Troubleshooting.....	6
Oil.....	7
Fuel.....	7
High Altitude Operation	8
Maintenance	8
Maintenance Chart.....	9
Carburetor Adjustment	9
Spark Plug Service	10
Spark Arrester Maintenance	11
Air Filter Service.....	11
Draining the Oil.....	11
Storage.....	12
Engine Specifications	13
Tune Up Specification.....	13
Warranty Information.....	13
Emission Information	14

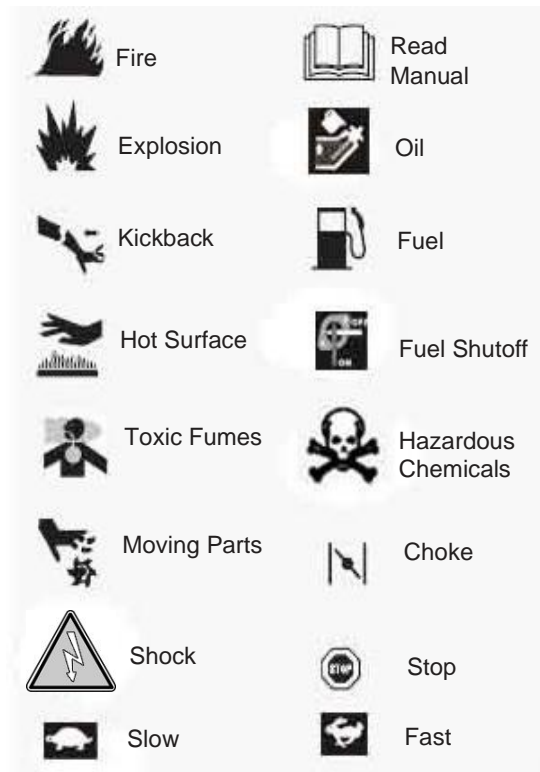
SYMOLS ASSOCIATED WITH THIS ENGINE



  This manual contains safety information to make you aware of the hazards and risks associated with engines, and how to avoid them. Because we do not necessarily know what equipment this engine will power, it is important that you read and understand these instructions and the instructions for the equipment this engine powers.

 WARNING
The engine exhaust from this product contains chemicals known to the State of California to cause cancer, birth defects, or other reproductive harm.

CAUTION
This engine is shipped from us without oil. If you start the engine without oil, the engine will be damaged beyond repair and will not be covered under warranty.

FEATURES AND CONTROLS

Compare the illustration with your engine to familiarize yourself with the location of various features and controls. Note: Not all features are on all engines.

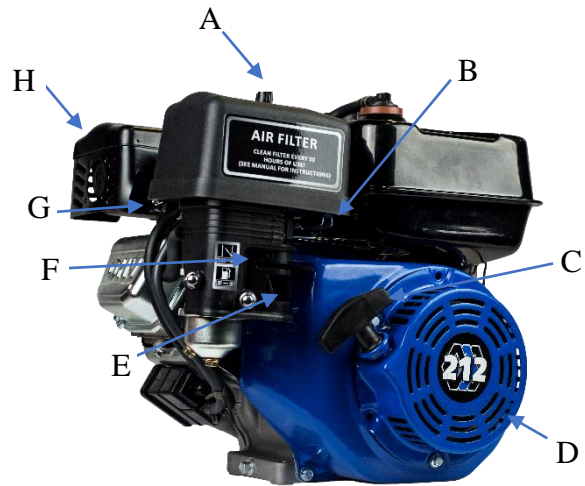

- A Air cleaner
- B Throttle lever
- C Starting handle
- D Recoil starter (under housing)
- E Fuel cock (if equipped)
- F Choke lever
- G Spark plug
- H Muffler
- I Fuel filler cap
- J Fuel tank
- K Oil Dipstick
- L Oil Drain Plug
- M Engine Identification Tags
- N Engine Switch



SAFETY

CAUTION

This engine is shipped from us without oil. If you start the engine without oil, the engine will be damaged beyond repair and will not be covered under warranty.

 	 WARNING
<p>Gasoline and its vapors are extremely flammable and explosive. Fire or explosion can cause severe burns or death.</p>	

WHEN ADDING FUEL

- Turn engine OFF and let engine cool at least 2 minutes before removing gas cap.
- Fill fuel tank outdoors or in well-ventilated area.
- Do not overfill fuel tank.
- Keep gasoline away from sparks, open flames, pilot lights, heat, and other ignition sources. Check fuel lines, tank, cap, and fittings frequently for cracks or leaks. Replace if necessary.

WHEN STARTING ENGINE

- Make sure spark plug, muffler, fuel cap and air cleaner are in place.
- Do not crank the engine with spark plug removed. If fuel spills, wait until it evaporates before attempting to start the engine.
- If engine floods, set choke to OPEN/RUN position, place throttle in FAST and crank until engine starts.

WHEN OPERATING EQUIPMENT



- Do not choke carburetor to stop engine.

WHEN TRANSPORTING EQUIPMENT



- Transport with fuel tank EMPTY.



WHEN STORING GASOLINE OR EQUIPMENT WITH FUEL IN TANK



- Store away from furnaces, stoves, water heaters or other appliances that have pilot light or other ignition source because they can ignite gasoline vapors.



 	 WARNING
<p>Starting engine creates sparking. Sparking can ignite nearby flammable gases. Explosion and fire could result.</p>	

- If there is natural or LP gas leakage in the area, do not start the engine.
- Do not use pressurized starting fluids because vapors are flammable.

	 WARNING
<p>Rapid retraction of starter cord (kickback) will pull your hand and arm toward engine faster than you can let go. Broken bones, fractures, bruises or sprains could result.</p>	
<ul style="list-style-type: none"> • When starting engine, pull cord slowly until resistance is felt, then pull rapidly. • Direct coupled equipment components such as, but not limited to, blades, impellers, pulleys, sprockets, etc., must be securely attached. 	







	 WARNING
<p>Rotating parts can contact or entangle hands, feet, hair, clothing, or accessories. Traumatic amputation or severe laceration can result.</p>	
<ul style="list-style-type: none"> • Operate equipment with guards in place. Keep hands and feet away from rotating parts. • Tie up long hair and remove jewelry. • Do not wear loose-fitting clothing, dangling drawstrings or items that could become caught. 	

	 DANGER
<p>Engines give off carbon monoxide, an odorless, colorless, poison gas. Breathing carbon monoxide can cause nausea, fainting or death.</p>	
<ul style="list-style-type: none"> • Start and run engine outdoors. • Do not start or run engine in enclosed area, even if doors or windows are open. 	

 	 WARNING
<p>Running engines produce heat. Engine parts, especially muffler, become extremely hot. Severe burns can occur on contact. Combustible debris, such as leaves, grass, brush, etc. can catch fire.</p>	
<ul style="list-style-type: none"> • Allow muffler, engine cylinder and fins to cool before touching. • Remove accumulated debris from muffler area and cylinder area. • Install and maintain in working order a spark arrester before using equipment on forest-covered, grass-covered, brush-covered unimproved land. The state of California requires this. Other states may have similar laws. Federal laws apply on federal 	

OPERATION

How to Start the Engine



 WARNINGS/DANGER	
	Fire Hazard. Gasoline and its vapors are extremely flammable and explosive.
	Fire or explosion can cause severe burns or death.
	Engines give off carbon monoxide, an odorless colorless, poison gas. Breathing carbon monoxide can cause nausea, fainting or death.
	Unintentional sparking can result in fire or electric shock.
	Unintentional start-up can result in entanglement or strangulation, traumatic amputation, or laceration.

➤ Pre Starting

- Check to make sure that the spark plug, muffler, fuel cap and air cleaner are in place and secured.
- Do not crank engine with spark plug removed.
- If engine floods, set choke (if equipped) to open/run position, move throttle (if equipped) to fast position and crank until engine starts.
- Start and run engine outdoors. · Do not start or run engine in enclosed area, even if doors or windows are open.

➤ Starting



- Check the oil level. See the **OIL** section below.
- Move the fuel cock (E), if equipped, to the ON position.
- Move the choke lever (F) the choke  position.
Note: Choke is usually unnecessary when restarting a warm engine.
- Move throttle lever (B) away from MIN. position, about 1/3 of way toward MAX. position.
- Turn the engine switch (N) to the ON position.
- **Recoil Start:** Firmly hold the starting handle (C). To avoid kickback, pull the starter cord handle slowly until resistance is felt, then pull rapidly.

 WARNING	
	Rapid retraction of starter cord (kickback) will pull your hand and arm toward engine faster than you can let go. Broken bones, fractures, bruises or sprains could result.
	<ul style="list-style-type: none"> • When starting engine, pull cord slowly until resistance is felt, then pull rapidly. • Direct coupled equipment components such as, but not limited to, blades, impellers, pulleys, sprockets, etc., must be securely attached.

- **Electric Start: (Optional; if equipped)** Turn the key to the Start position, then hold it there until the engine starts. If using an electric starter with an extension cord, use only a 3-wire (grounded) cord. Do not use any cord that is damaged. **Do not attempt to replace any electric connection.** Any damaged electric cord should be replaced by an authorized service agent or similarly qualified person to avoid shock or other hazards.

Note: If engine fails to start within 5 seconds, release the key, and wait at least 10 seconds before operating the starter again.

How to Stop the Engine

 WARNINGS	
	Fire Hazard. Gasoline and its vapors are extremely flammable and explosive.
	Fire or explosion can cause severe burns or death.

- Move throttle lever (B) to MIN. position.
- Turn engine switch (N) to the OFF position.
- Turn fuel cock (E) to the OFF position.

Troubleshooting

Problem	Possible Cause	Possible Solution
Engine won't start	Out of fuel	Check the fuel level and fill if necessary
	Engine is Cold	Close the choke (set to the start position)
	Engine is flooded	Set the choke to the open/run position
	Dirty or bad spark plug	Remove the spark plug and clean it. Check the spacing on the electrode and set the gap to the correct dimension. See <i>Maintenance—Spark Plug Service</i> . If plug is damaged, replace with a new spark plug. Ensure the spark plug is installed and wire is connected.  Warning: Do not crank the engine with the spark plug removed.
Electric start won't work (if equipped)	Bad battery	Check capacity. Start with pull start and let battery recharge. If still no charge, replace battery.
	Fuse burned out	Replace fuse.

Oil

➤ **Prior to first using the engine, it must be filled with oil.** To fill oil follow these steps (See Figure 1):

- Place engine on a level surface.
- Unscrew the dipstick from the filler neck
- Add approximately 580 ml of high-quality SAE 10W-30 or other suitable grade for the operating conditions (See chart). To add oil, pour the oil slowly into the engine oil fill hole (O). Use of a funnel is recommended. **Do not overfill.**
- Check the oil level by inserting the dipstick *without screwing it in* and removing. Add additional oil until the oil level reaches the FULL mark (P) on the dipstick. Wipe off the oil on the dipstick after each check.
- After adding oil, wait one minute and then recheck the oil level. When full, replace and tighten the dipstick.

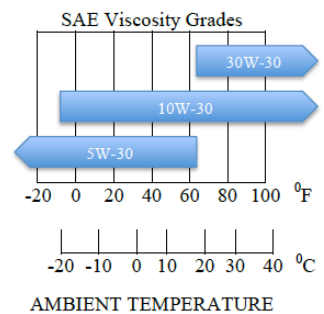
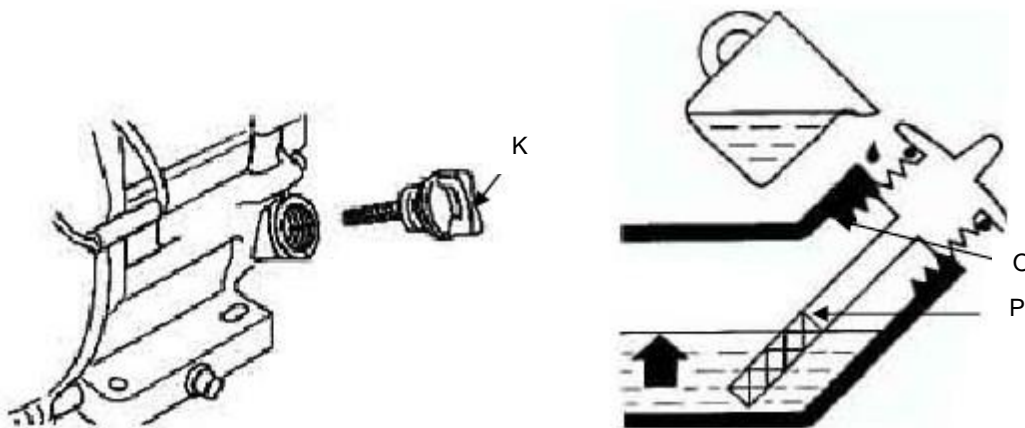

Figure 1



➤ **Check the oil level BEFORE EACH USE** with the engine stopped and on a level surface.

CAUTION: Use **only 4-stroke motor oil** that meets or exceeds the requirements for API service classification **SAE 10W-30** is recommended for general, all-temperature use. Other viscosities shown in the chart may be used when the average temperature in your area is within the indicated range.



Fuel

➤ **Fuel must meet these requirements:**

- Clean, fresh, unleaded gasoline.
- A minimum of 87 octane/87 AKI (91 RON). For high altitude use, see below.
- Gasoline with up to 10% ethanol (gasohol) or up to 15% MTBE (methyl tertiary butyl ether) is acceptable.

CAUTION: Do not use unapproved gasoline, such as E85. Do not mix oil in gasoline or modify the engine to run on alternate fuels. This will damage the engine components and void the engine warranty. To protect the fuel system from gum formation, mix a fuel stabilizer into the fuel. See **Storage**. All fuel is not the same. This engine is certified to operate on gasoline. The emissions control system for this engine is EM (Engine Modifications).

➤ **Adding Fuel**

 WARNINGS	
	Fire Hazard. Gasoline and its vapors are extremely flammable and explosive.
	Fire or explosion can cause severe burns or death.





- Turn engine off and let engine cool at least 2 minutes before removing the fuel cap.
- Clean the fuel cap area of dirt and debris. Remove the fuel cap.
- Fill fuel tank outdoors or in well-ventilated area.
- Do not overfill fuel tank. Fill tank to approximately 1.5 inches (38 mm) below top of neck to allow for fuel expansion.
- **Keep gasoline away from sparks, open flames, pilot lights, heat, and other ignition sources.**
- Check fuel lines, tank, cap, and fittings frequently for cracks or leaks. Replace if necessary.
- If fuel spill, wait until it evaporates before starting engine.
- Reinstall the fuel cap.

High Altitude Operation

Your engine is configured for operation below 2,000 feet altitude at the factory. Your engine must be reconfigured for operation above 2,000 feet altitude. Operating the engine with the wrong engine configuration at a given altitude may increase its emissions, decrease fuel efficiency, degrade performance, and cause irreversible damage. Engines configured for high altitude operation cannot be operated in standard altitude conditions. A qualified service center should ensure that your engine is properly configured for your location.

MAINTENANCE

CAUTION: All the components used to build this engine must remain in place for proper operation. **Use only original Tillotson® or original part manufacturer replacement parts. Other parts may not perform as well, may damage the unit, and may result in injury.** In addition, use of other parts may void your warranty. Contact us or your local dealer for genuine Tillotson® parts.

 WARNINGS	
	Unintentional sparking can result in fire or electric shock.
	Unintentional start-up can result in entanglement or strangulation, traumatic amputation, or laceration.
	Fire Hazard.

➤ **Before performing adjustments or repairs:**

- Disconnect the spark plug wire and keep it away from the spark plug.
- Use only correct tools.
- Do not tamper with the governor spring, links or other parts to increase engine speed.
- Replacement parts must be the same and installed in the same position as the original parts.
- Do not strike the flywheel with a hammer or hard object. Doing so may damage or weaken the flywheel and may cause it to later shatter during operation.

➤ **When testing for spark:**

- Use approved spark plug tester.
- Do not choke for spark with spark plug removed.

Maintenance Chart

First 5 Hours
<ul style="list-style-type: none">• Change Oil
Every 8 Hours or Annually
<ul style="list-style-type: none">• Check engine oil level• Check muffler and muffler guard and spark arrester (if applicable)
Every 50 Hours or Annually
<ul style="list-style-type: none">• Change engine oil• Check muffler and muffler guard and spark arrester (if applicable)
Annually
<ul style="list-style-type: none">• Replace spark plug• Check valve clearance

Carburetor Adjustment

Never make adjustments to the carburetor. The carburetor was set at the factory to operate efficiently under most conditions. However, if adjustments are required, see any our Authorized Dealer for service. In particular, if operating above 2,000 feet altitude, the carburetor may need to be adjusted and should only be done at an Authorized Dealer

CAUTION: The manufacturer of the equipment on which this engine is installed may specify the top speed at which the engine will be operated. **Do not exceed the manufacturer’s recommended speed.**

Spark Plug Service

To ensure proper engine operation, the spark plug must be properly gapped and free of deposits. If the engine has been running, the muffler will be very hot. Be careful not to touch the muffler.

- Remove spark plug cap.
- Clean any dirt from around the spark plug base.
- Use a spark plug wrench to remove the spark plug.
- Visually inspect the spark plug. Discard it if the insulator is cracked, chipped or fouled.
- Measure the plug gap with a feeler gauge. Correct as necessary by carefully bending the side electrode.

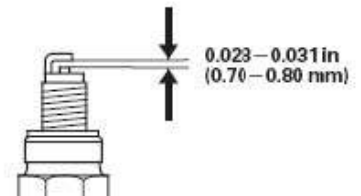



The gap should be 0.023-0.031 inches (0.70-0.80 mm)

- Check that the spark plug washer is in good condition. Thread the spark plug in by hand to prevent cross-threading.
- After the spark plug is seated, tighten with the spark plug wrench to compress the washer.
 - If installing a new spark plug, tighten ½ turn after the spark plug seats to compress the washer. If reinstalling a used spark plug, tighten ⅛ - ¼ turn after the spark plug seats to compress the washer.



Caution: The spark plug must be securely tightened. An improperly tightened spark plug can become very hot and could damage the engine. Never use spark plugs which have an improper heat range. Use only recommended spark plugs or equivalent.

Muffler and Spark Arrester (if applicable) Inspection

 WARNINGS	
	Running engines produce heat. Engine parts, especially muffler, become extremely hot.
	Severe burns can occur on contact. Combustible debris, such as leaves, grass, brush, etc. can catch fire.

- Allow muffler, engine cylinder and fins to cool before touching.
- Remove accumulated debris from muffler area and cylinder area.

WARNING: Replacement parts must be the same and installed in the same position as the original parts or fire could result.

Spark Arrester Maintenance

If the engine has been running, the muffler will be very hot. Allow it to cool before proceeding.

	<p>CAUTION: The spark arrester must be serviced every 100 hours to maintain its efficiency. Clean the spark arrester as follows:</p> <ul style="list-style-type: none">➤ Loosen the screw by the exhaust port of the muffler and remove the spark arrester.➤ Use a brush to remove carbon deposits from the spark arrester screen. Inspect the screen for breaks or tears and replace it if necessary.➤ Install the spark arrester in the reverse order of removal.
---	--

Air Filter Service (see Figure 2)

- Remove the air filter outside cover (Q). Be careful to prevent dirt and debris from falling into the air filter assembly.
- Separate the air filter over (Q) from the air filter housing (R).
- Inspect the air filter element. Clean dirty air filter with warm water and mild soap. Allow air filter to dry thoroughly before re-installation. **Note: Do not use pressurized air or solvents to clean the filter.** Pressurized air can damage the filter and solvents will dissolve the filter.
- Re-install the air filter element and cover.

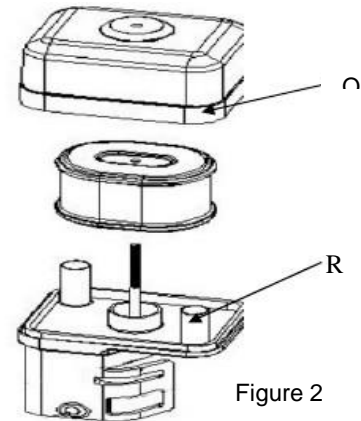



Figure 2

Draining the Oil

	<p>CAUTION Used oil is a hazardous waste product and must be disposed of properly. Do not discard with household waste. Check with your local authorities, service center, or dealer for safe disposal/recycling facilities.</p>
	<p>WARNING: Before draining the oil from the oil drain plug, the fuel tank must be empty; otherwise, fuel may leak out and result in fire or explosion. To empty the fuel tank, run engine until it stops from lack of fuel.</p>

Use the Oil Drain Plug to drain the oil (See Figure 3):

- Remove the oil dipstick (K)
- Place an approved container below the oil drain plug.
- Remove the oil drain plug (L) and allow oil to drain into the approved container.
- When fully drained, re-install oil drain plug (k) and wrench tighten.

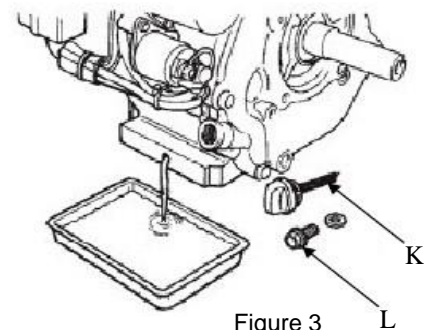

Figure 3

CAUTION: Refill oil before next use (See *Operation-Oil*).

Operating the engine without sufficient oil will damage the engine and void the warranty.

STORAGE

WARNINGS

When storing fuel or equipment with fuel in tank:

- Store away from furnaces, stoves, water heaters, or other appliances that have a pilot light or other ignition source because they can ignite vapors.

When Transporting Equipment:

- Transport with fuel tank EMPTY or with fuel shut-off valve OFF.

The following precautions should be taken if storing your engine for more than 30 days or for seasonal storage:

- While the engine is still warm, change oil.
- Clean engine of surface debris, including any grass or dirt
- Drain all fuel from the fuel tank into a proper receptacle for storage.
- Remove spark plug. Place 1 teaspoon or 5 ml of oil into the spark plug hole
- Pull starter rope **slowly** 8-10 times to properly coat the cylinder bore and piston for storage.
- Replace spark plug and tighten. Note that Any residual oil may burn off in subsequent starts. This may result in white smoke emission from muffler, which should dissipate in a few minutes.
- Store the engine upright in a clean, dry area. Storing or transporting the engine with the spark plug down will result in hard starting and/or engine smoking.

When removing the unit from storage, only use fresh gasoline. Perform operation checks (see maintenance schedule) before starting engine.

CAUTION: Fuel should always be drained when engine will not be used for more than 30 days because fuel evaporates and degrades over time, and the residue can gum up the carburetor and engine components. To protect against degradation in the fuel, we recommend adding a fuel stabilizer when filling the engine. The fuel stabilizer can help maintain the integrity of the fuel for a longer period of time and provide some protection against unplanned non-use. However, the fuel stabilizer will not fully prevent the degradation and the fuel should be drained if the engine remains unused.

ENGINE SPECIFICATIONS

	<u>TPP-196R</u>	<u>TPP-208E</u>	<u>TPP-212E and -212EE</u>
Displacement	196cc	208cc	212cc
Bore	68 mm 2.68 in)	70 mm (2.76 in)	70 mm (2.76 in)
Stroke	54 mm (2.12 in)	54 mm (2.12 in)	55 mm (2.12 in)
Oil Capacity	600 ml (.16 gal)	600 ml (.16 gal)	600 ml (.16 gal)
Intake Valve Lash		0.10mm to 0.15mm	
Exhaust Valve Lash		0.15mm to 0.20mm	

TUNE-UP SPECIFICATIONS

	<u>TPP-196R</u>	<u>TPP-208E</u>	<u>TPP-212E and -212EE</u>
Spark Plug Gap	0.7-0.8mm (0.028-0.03 in)		
Spark Plug Torque	18-22 Nm		
Intake Valve Clearance	0.8-0.12 mm (0.003-0.005 in)		
Exhaust Valve Clearance	0.1-0.18mm (0.005-0.007 in)		
Torque Settings			
Connecting Rod	13 N.m		
Engine side cover bolts	30 N.m		
Head Bolts	30 N.m		
Flywheel Nut	75 N.m		

WARRANTY INFORMATION

Tillotson Power Products LLC warrants to the original purchaser that this product is free from defects in materials and workmanship for the period of 90 days from the date of purchase. This warranty does not apply to damage due directly or indirectly to misuse, abuse, negligence or accidents, repairs or alterations outside our facilities, criminal activity, improper installation, normal wear and tear, or to lack of maintenance. We shall in no event be liable for death, injuries to persons or property, or for incidental, contingent, special or consequential damages arising from the use of our product. Some states do not allow the exclusion or limitation of incidental or consequential damages, so the above limitation of exclusion may not apply to you. THIS WARRANTY IS EXPRESSLY IN LIEU OF ALL OTHER WARRANTIES, EXPRESS OR IMPLIED, INCLUDING THE WARRANTIES OF MERCHANTABILITY AND FITNESS, EXCEPT FOR THE EMISSIONS CONTROL SYSTEM WARRANTY BELOW.

To take advantage of this warranty, the product or part must be returned to us with transportation charges prepaid. Proof of purchase date and an explanation of the complaint must accompany the merchandise. If our inspection verifies the defect, we will either repair or replace the product at our election or we may elect to refund the purchase price if we cannot readily and quickly provide you with a replacement. We will return repaired products at our expense, but if we determine there is no defect, or that the defect resulted from causes not within the scope of our warranty, then you must bear the cost of returning the product.

This warranty gives you specific legal rights and you may also have other rights which vary from state to state.

For Warranty or other service matters, contact your local dealer or call **1-866-591-8921**. You can also email us at Service@TillotsonPower.com

EMISSIONS CONTROL SYSTEM WARRANTY

In addition the Limited Warranty provided above, Tillotson Power Products LLC (“**TPP**”) warrants that the emissions control system on your engine is designed, built, and equipped so that it conforms to the emissions requirements of the United States Environmental Protection Agency (the “**EPA**”) in effect at the time of manufacture. TPP also warrants that the emissions control system on your engine will be free from defects in material and workmanship for two (2) years from the date of purchase, provided there has been no improper maintenance, misuse, or abuse of your engine.

WHAT WE WILL DO

Where a warrantable condition exists, TPP will repair or replace, at our option, any emissions-related part on your engine if it becomes defective, malfunctions, or otherwise fails to conform with this warranty under normal use and service during the two (2) year term of this warranty at no cost to you, including diagnosis, parts and labor. This warranty applies to the original purchaser and any subsequent owner within the two year warranty period.

WHAT IS COVERED?

The following parts are examples of components of the emissions control system and are covered by this two (2) year warranty. For a full list of emissions control components covered by this warranty, please see 40 CFR §1068, Appendix I.

1. Fuel Metering System
 - a. Carburetor and its internal parts
 - b. Fuel pump (if so equipped)
 - c. Cold start enrichment system
2. Air Induction System
 - a. Intake pipe/manifold.
 - b. Air cleaner
3. Ignition System
 - a. Spark plug
 - b. Magneto ignition system
4. Catalyst System (if so equipped)
 - a. Exhaust pipe stud
 - b. Muffler
 - c. Catalytic converter (if so equipped)
5. Miscellaneous Items Used in Above Systems
 - a. Vacuum, temperature and time sensitive valves and switches
 - b. Hoses, belts, connectors, and assemblies

This warranty does not cover normal maintenance services or replacement of maintenance items such as filters, oils, or spark plugs.

WHAT YOU MUST DO TO OBTAIN WARRANTY SERVICE

As the engine owner, you are responsible for the performance of the required maintenance listed in your Owner’s Manual. TPP may deny you warranty coverage if your engine or a part has failed due to abuse (including failure to follow the fuel use instructions contained in this manual), neglect, improper maintenance, or unapproved modifications.

In order to obtain warranty repair or replacement, you may either (a) contact TPP product support at 1-866-591-8921 or service@tillotsonpower.com; or (b) bring the engine to your nearest dealer. When going to the retail store or contacting product support, you must indicate the specific emissions control part or defect that you are claiming and the date this was originally purchased.